



SURGICAL INSTRUMENTS CATALOGUE

Diagnostics



Buck
AC-1-102-18
20cm,



Buck
AC-1-101-18
Percussion Hammer
18.5 cm,



Dejerine
AC-1-103-20
Percussion Hammer
20cm,



Dejerine
AC-1-104-21
Percussion Hammer
21cm,



Taylor Mod. USA
AC-1-105-20
Percussion Hammer
20cm,



Wartenberg
AC-1-106-19
Pinwheel
18cm,

Diagnosics



Pinard
AC-1-107-18
Stethoscope
18 cm,



Pinard
AC-1-108-15
Stethoscope
15cm,

Anesthesia



Magill
AC-2-101-15
Catheter Introducing Forceps
14.5 cm, 20 cm, 25 cm,



Miller
AC-2-102-00
Laryngoscope Sets



Miller-Baby
AC-2-103-00
Laryngoscope Sets



Miller
AC-2-104-00
Laryngoscope Blade
Fig. 0, Fig. 1, Fig. 2, Fig. 3, Fig. 4,



Guedel-Negus
AC-2-105-00
Laryngoscope Sets
Fig. 2, Fig. 3, Fig. 4,



Guedel-Negus
AC-2-106-00
Laryngoscope Sets
Fig. 1, Fig. 2, Fig. 3, Fig. 4,

Anesthesia



Guedel-Negus
AC-2-107-01
Laryngoscope Blades
Fig. 1, Fig. 2, Fig. 3, Fig. 4,



McIntosh
AC-2-108-00



McIntosh
AC-2-109-00
Laryngoscope Blades
Fig. 0, Fig. 1, Fig. 2, Fig. 3, Fig. 4,



McIntosh
AC-2-110-00
Laryngoscope Sets
Fig. 1, Fig. 2, Fig. 3, Fig. 4,



Foregger
AC-2-111-01
Laryngoscope Blades
Fig. 1, Fig. 2, Fig. 3, Fig. 4,



Battery Handle
AC-2-112-00
Battery Handle

Anesthesia



McIntosh
AC-2-114-00
Laryngoscope Sets fiber optic
Fig. 1, Fig. 2, Fig. 3,



McIntosh
AC-2-115-00
Laryngoscope Sets fiber optic
Fig. 1, Fig. 2, Fig. 3,



McIntosh
AC-2-116-00
Laryngoscope Sets fiber optic
Fig. 1, Fig. 2, Fig. 3,



McIntosh
AC-2-113-00
Laryngoscope Sets
Fig. 1, Fig. 2, Fig. 3, Fig. 4,



Trocars



Universal
AC-3-101-04
Trocar
14 cm,



Nelson
AC-3-102-07
Trocar
20 cm,



Lichtwitz
AC-3-103-19
Antrum Trocar
18.5 cm,



Adson
AC-3-104-21
Suction Cannula
20 cm,



Frazier
AC-3-105-10
Suction Cannula
24 cm,



Frazier
AC-3-106-06
Suction Cannula
19.5 cm,



Trocars



Poppen
AC-3-107-06
Suction Cannula
18 cm,



Luer
AC-3-108-30
Suction Tube working length 110 mm



Yasargil
AC-3-109-15
Suction Tube working length 150 mm with
Luer hub
21.5 cm,



Yankauer
AC-3-110-27
Suction Tube complete with suction tip and
connector
31 cm,



Yankauer
AC-3-111-00
Suction Tube
31 cm, 15 cm, 2.5 cm, 10 cm,



Poole
AC-3-112-22
Suction Tube
22 cm,

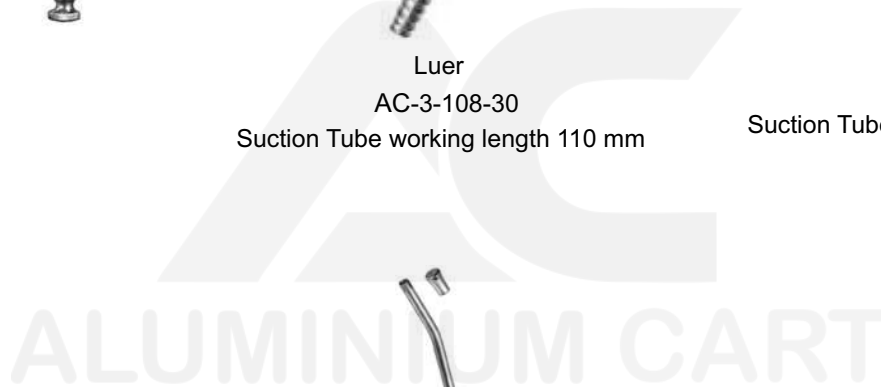

Trocars



Poole
AC-3-113-22
Suction Tube
22.5 cm,



Nuboer
AC-3-114-21
Suction Tube
21 cm,



Nuboer
AC-3-115-21
Suction Tube
21 cm,



Quinke
AC-3-116-10
Lumbar Puncture Needle



Tuohy
AC-3-117-12
Lumbar Puncture Needle Luer Lock
connection with special tip



Verres
AC-3-118-20
Insufflation Cannula Luer Lock connection
15 cm,

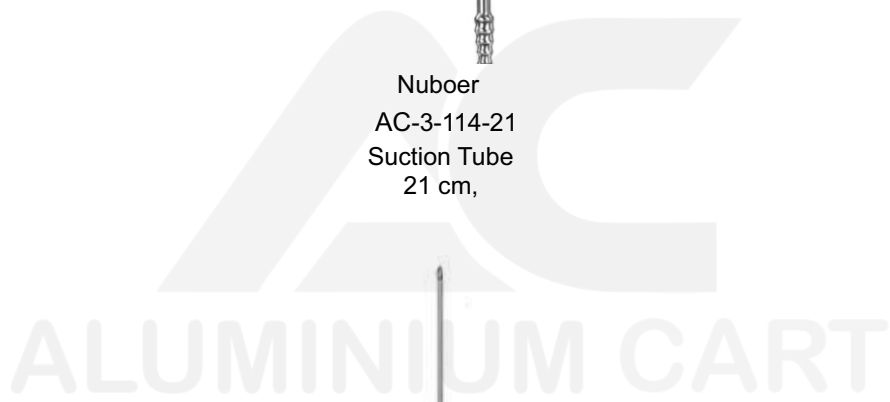

Trocars



Verres

AC-3-119-20

Insufflation Cannula Luer Lock connection
17 cm,

Suture



Kalt
AC-4-105-14
Needle Holder
13.5 cm,



Barraquer-Troutman
AC-4-106-10
Micro Needle Holder
10 cm, 10.5 cm,



Arruga
AC-4-107-14
Micro Needle Holder
13.5 cm,



Barraquer-Troutman
AC-4-108-10
Micro Needle Holder
10.5 cm, 11.5 cm,



Barraquer
AC-4-109-11
Micro Needle Holder
11.5 cm, 13.5 cm, 14 cm,



Barraquer
AC-4-110-13
Micro Needle Holder
13.5 cm,



Suture



Castroviejo-Fino
AC-4-111-01
Micro Needle Holder
13 cm,



Castroviejo-Fino
AC-4-112-01
Micro Needle Holder
13 cm,



Castroviejo-Fino
AC-4-113-01
very delicate jaw with lock
13 cm,



Castroviejo
AC-4-114-14
Micro Needle Holder with lock
14 cm,



Castroviejo
AC-4-115-14
Micro Needle Holder
14 cm,



Castroviejo
AC-4-121-14
Micro Needle Holder with lock
14 cm,



Suture



Castroviejo
AC-4-122-14
Micro Needle Holder
14 cm,



Castroviejo
AC-4-124-13
Micro Needle Holder with lock
12 cm,



Arruga
AC-4-123-16
Needle Holder delicate
16 cm,



Castroviejo
AC-4-125-12
Micro Needle Holder with lock
12 cm,



Derf
AC-4-126-12
Needle Holder
12 cm, 13 cm,

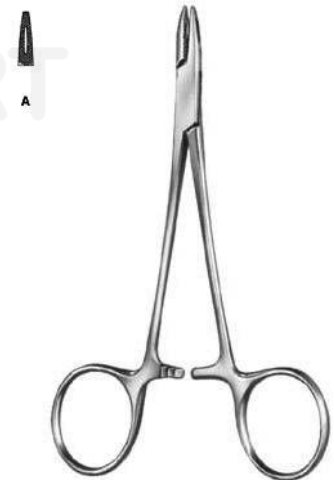

Collier
AC-4-127-12
Needle Holder
12.5 cm,



Suture



Webster
AC-4-128-13
Needle Holder
13 cm,

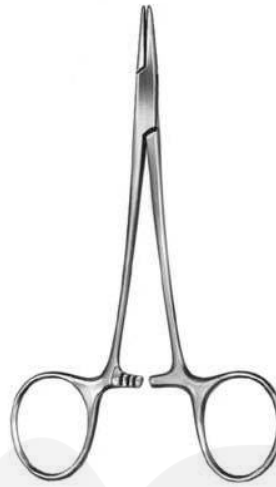

Halsey
AC-4-129-13
Needle Holder
13.5 cm,



Neivert
AC-4-130-13
Needle Holder
12.5 cm,



Hegar-Baumgartner
AC-4-131-14
Needle Holder
14.5 cm,



Crile-Murray
AC-4-133-15
Needle Holder
15 cm,



Crile-Wood
AC-4-134-15
Needle Holder
15 cm,

Suture



Adson
AC-4-140-18
Needle Holder one fenestrated jaw
18 cm,



Metzenbaum
AC-4-141-18
Needle Holder one grooved and fenestrated
jaw
18.5 cm,



M. G. Hospital
AC-4-142-17
Needle Holder
17.5 cm,

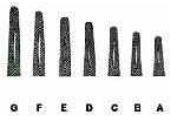

Mayo-Hegar
AC-4-143-14
Needle Holder
14.5 cm, 16 cm, 18.5 cm, 20.5 cm, 24 cm, 26.5
cm,



Mayo-Hegar
AC-4-144-16
Needle Holder
16 cm, 18.5 cm, 20.5 cm,



Brown
AC-4-145-13
Needle Holder
13 cm, 18 cm,

Suture

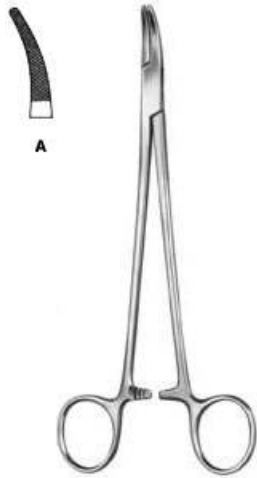

Heaney
AC-4-146-21
Needle Holder
20.5 cm,

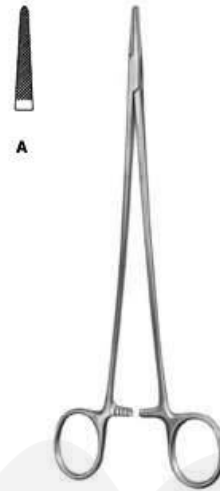

Jamison
AC-4-147-23
Needle Holder
23.5 cm,



Masson
AC-4-148-27
Needle Holder
26.5 cm,

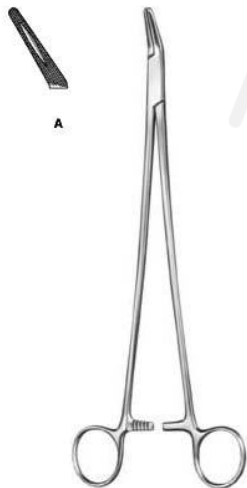

Finochietto
AC-4-149-27
Needle Holder
26.5 cm,



Wangenstein
AC-4-150-27
Needle Holder
26.5 cm,

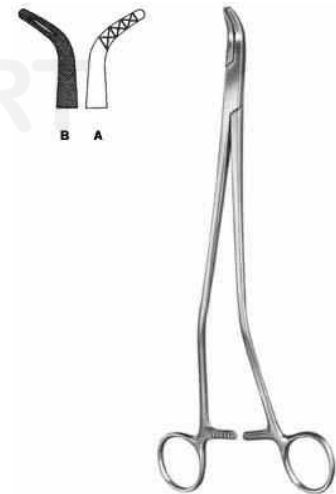

Johnson
AC-4-151-27
Needle Holder
27 cm,



Suture

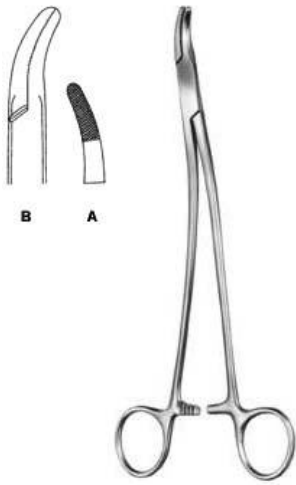

Stratte
AC-4-152-23
Needle Holder
23 cm,

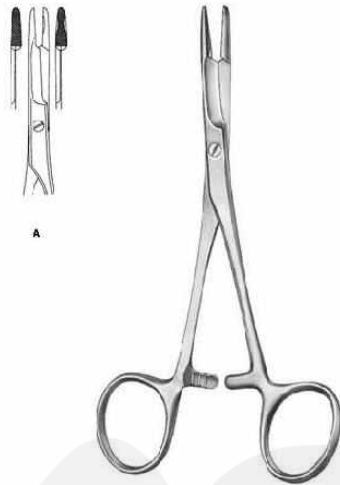

Olsen-Hegar
AC-4-153-14
Needle Holder
14 cm,

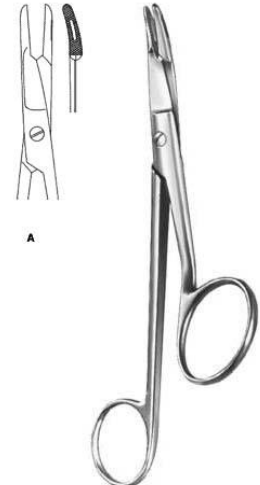

Gillies
AC-4-154-16
Needle Holder
16 cm,



Crile
AC-4-155-15
Needle Holder
15 cm,



Mathieu
AC-4-156-14
Needle Holder
14 cm, 17 cm, 20 cm,



Mathieu
AC-4-157-14
Needle Holder
14 cm, 16.5 cm,



Suture



Toennis
AC-4-158-18
Needle Holder
18.5 cm,



Lichtenberg
AC-4-159-20
Needle Holder
20 cm,



AC-4-160-16
Micro Needle Holder
16 cm,



AC-4-161
Micro Needle Holder
23 cm, 19 cm,



Hepp-Scheidel
AC-4-162-18
Micro Needle Holder smooth jaw
18 cm,



Webster
AC-4-163-13
Needle Holder with automatic release ratchet
also for lefthanders
13 cm, 15 cm,



Suture



AC-4-164-15
Micro Needle Holder
15 cm, 18 cm, 21 cm, 23 cm,



JABOMA
AC-4-165-18
Micro Needle Holder
18 cm,



Castroviejo
AC-4-166
Micro Needle Holder
14.5 cm, 18 cm, 21.5 cm,



Arruga
AC-4-167
Needle Holder
16 cm,



Castroviejo
AC-4-168-13
Micro Needle Holder
12.5 cm,



Barraquer
AC-4-169-13
Micro Needle Holder
13 cm,

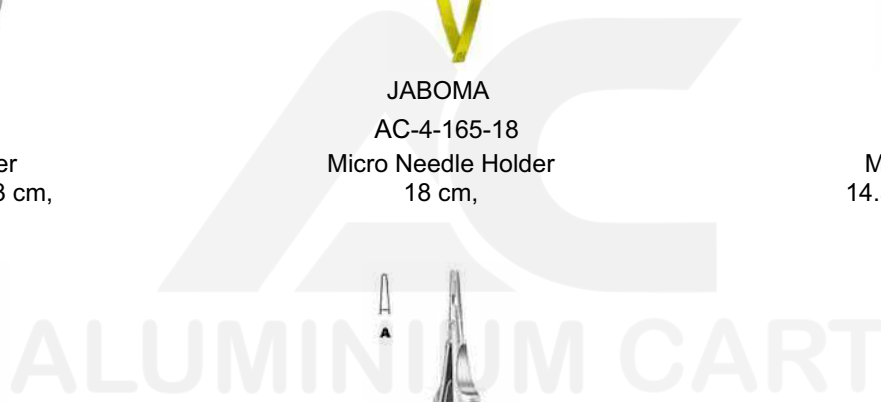

Suture



Barraquer
AC-4-170-13
Micro Needle Holder
13 cm,



Webster
AC-4-171-13
Needle Holder
13 cm,



Derf
AC-4-173-12
Needle Holder
12 cm,

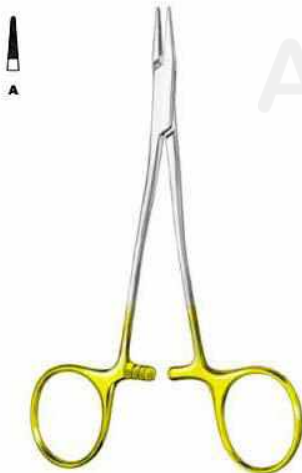

Kilner
AC-4-172-13
Needle Holder
13 cm,



Hegar-Baumgartner
AC-4-174-13
Needle Holder
13 cm, 14.5 cm,



Halsey
AC-4-175-12
Needle Holder
13 cm, 12 cm,

ALUMINIUM CART

Suture



Crile-Wood
AC-4-176-15
Needle Holder
15 cm,



Sarot
AC-4-177-18
Needle Holder
18 cm, 20 cm, 26 cm,

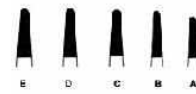

Mayo-Hegar
AC-4-178-16
Needle Holder standard profile
16 cm, 18 cm, 20 cm, 24 cm, 26 cm, 30 cm,



Heaney
AC-4-179-20
Needle Holder
20 cm, 24 cm, 26 cm,



DeBakey
AC-4-180-18
Needle Holder delicate pattern mini profile
18 cm, 20 cm, 23 cm, 26 cm, 31 cm,



Masson
AC-4-181-27
Needle Holder
26.5 cm,



Suture



Barraquer
AC-4-170-13
Micro Needle Holder
13 cm,



Webster
AC-4-171-13
Needle Holder
13 cm,



Derf
AC-4-173-12
Needle Holder
12 cm,

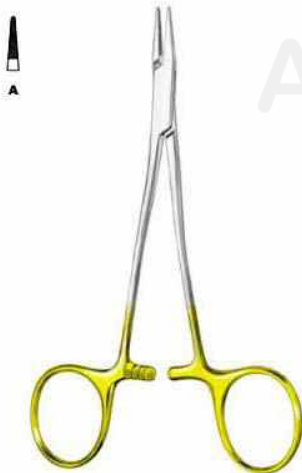

Kilner
AC-4-172-13
Needle Holder
13 cm,



Hegar-Baumgartner
AC-4-174-13
Needle Holder
13 cm, 14.5 cm,



Halsey
AC-4-175-12
Needle Holder
13 cm, 12 cm,



Suture



Ryder (Martin)
AC-4-182-13

Needle Holder

12.5 cm, 15 cm, 18 cm, 20 cm, 23 cm, 26 cm,



Martin

AC-4-183-15

Needle Holder mini profile elastic type
15 cm, 17 cm, 20 cm,



Wangenstein

AC-4-184-27

Needle Holder standard profile
27 cm,



Hegar-Vascular

AC-4-185-14

Needle Holder micro profile
14 cm, 18.5 cm, 20.5 cm, 23 cm,

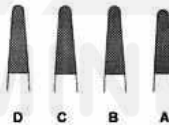

Bozemann

AC-4-186-20

Needle Holder standard profile
20.5 cm, 24 cm, 26.5 cm, 29 cm,



Hegar

AC-4-187-20

Needle Holder standard profile
20 cm, 23.5 cm,

Suture



Lichtenberg
AC-4-194-20
Needle Holder lightweight model standard
profile
20 cm,



Langenbeck
AC-4-195-18
Needle Holder
18 cm, 20.5 cm, 23 cm,



Zweifel
AC-4-196-20
Needle Holder with hinged ratchet standard
profile
20.5 cm, 23 cm,



Reverdin
AC-4-197-15
Reverdin Needle short
14.5 cm Fig. 1, 14.5 cm Fig. 2, 14.5 cm Fig.
3, 14.5 cm Fig. 4,



Reverdin
AC-4-198-19
Reverdin Needle medium
19.5 cm Fig. 1, 19.5 cm Fig. 2, 19.5 cm Fig.
3, 19.5 cm Fig. 4,

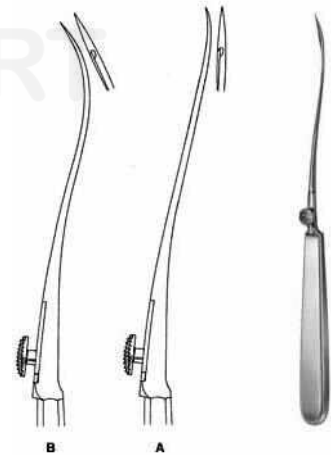

Reverdin
AC-4-199-23
Reverdin Needle long
23 cm Fig. 1, 23 cm Fig. 2, 23 cm Fig. 3, 23 cm
Fig. 4,

Suture

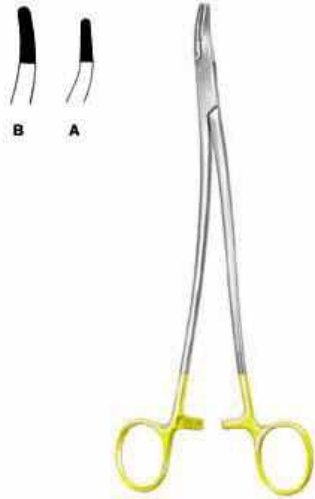

Stratte
AC-4-188-22
Needle Holder standard profile
23 cm,



Microvascular
AC-4-189-00
Needle Holder slender pattern micro profile
14 cm, 17.5 cm, 20 cm, 23 cm,



Mathieu
AC-4-190-14
Needle Holder
14 cm, 17 cm, 20 cm,



Mathieu
AC-4-191-14
Needle Holder
14 cm, 17 cm, 20 cm,



Mathieu
AC-4-192-17
Needle Holder standard profile with interior
ratchet
17 cm, 20 cm, 23 cm,



Toennis
AC-4-193-18
Needle Holder
18.5 cm,

ALUMINIUM CART

Suture

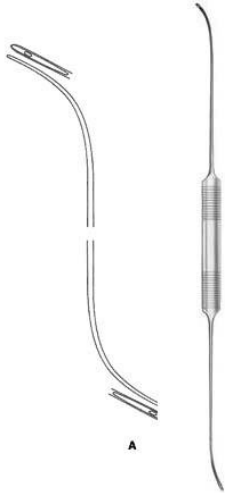

Schmieden-Dick
AC-4-201-01
Ligature Needle malleable
29 cm,

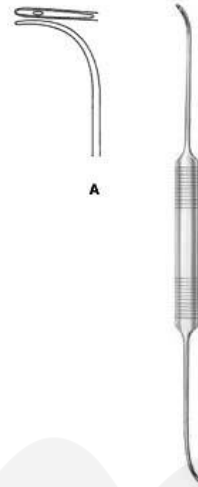

Schmieden
AC-4-202-21
Ligature Needle
24 cm,



AC-4-203-20
Ligature Needle malleable
20.5 cm,

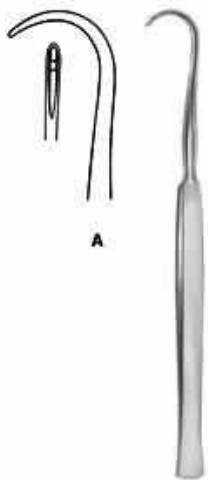

Cooper
AC-4-204-19
Ligature Needle
18.5 cm,



Kronecker
AC-4-205-13
Ligature Needle delicate for right hand
12.5 cm,

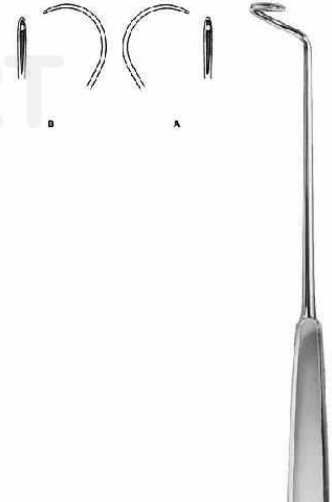

Deschamps
AC-4-206-24
Ligature Needle blunt for right hand
24 cm,

Suture



Deschamps
AC-4-207-20
Ligature Needle blunt for right hand
20 cm,



Deschamps
AC-4-208-20
Ligature Needle sharp for right hand
20 cm,

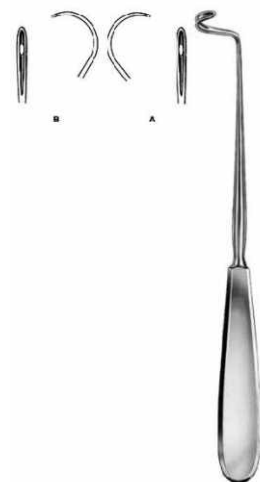

Deschamps
AC-4-209-21
Ligature Needle blunt for right hand
20 cm,

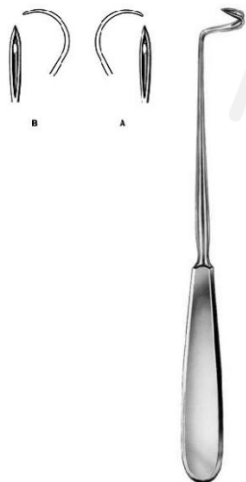

Deschamps
AC-4-210-21
Ligature Needle sharp for right hand
20 cm,

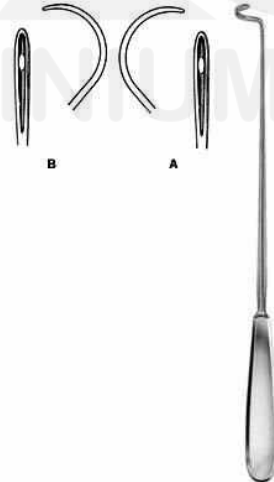

Deschamps
AC-4-211-27
Ligature Needle blunt for right hand
27 cm,

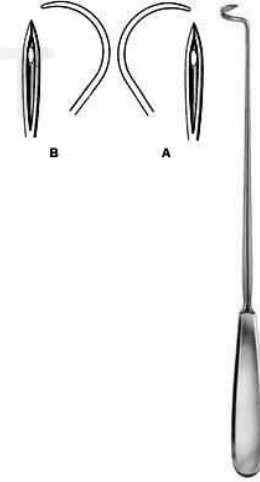

Deschamps
AC-4-212-27
Ligature Needle sharp for right hand
27 cm,

Suture

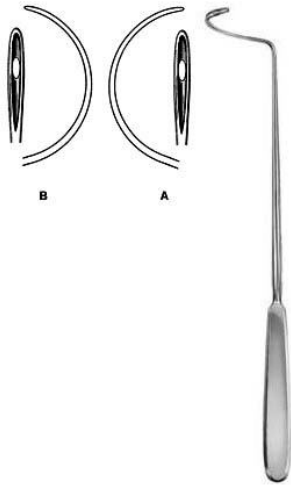

Deschamps
AC-4-213-28
Ligature Needle blunt for right hand
28 cm,



Deschamps
AC-4-214-20
Ligature Needle sharp for right hand
20 cm,



Deschamps
AC-4-215-20
Ligature Needle blunt for right hand
20 cm,



Deschamps
AC-4-216-20
Ligature Needle blunt for right hand
21 cm,

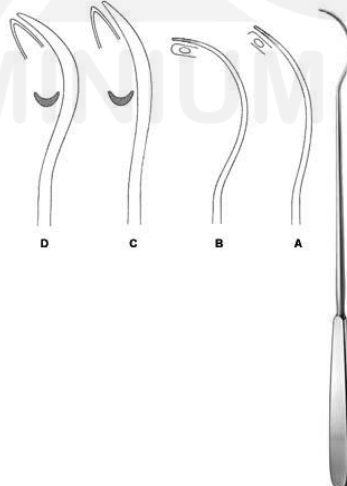

Brunner
AC-4-217-30
Ligature Needle
21 cm,



Kirschner
AC-4-218-25
Ligature Conductor
25.5 cm,

Suture

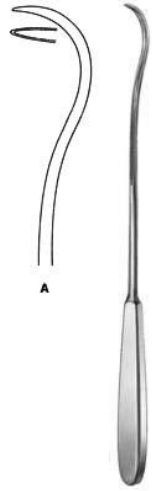

AC-4-219-28
Ligature Conductor
28 cm,



Modell Wien
AC-4-220-23
Ligature Catcher
23.5 cm,



Michel
AC-4-221-12
Clip Applying Forceps
12 cm,



Hegenbarth
AC-4-222-12
Clip Applying Forceps
12 cm,

ALUMINIUM CART

Scalpels



AC-5-101-01
Dissecting Knife with metal handle
15 cm, 15.5 cm, 16 cm, 17 cm,



AC-5-102-10
Autopsy Knife
25.5 cm,

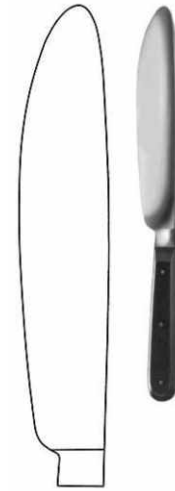

Walb
AC-5-104-17
Post Mortem Knife

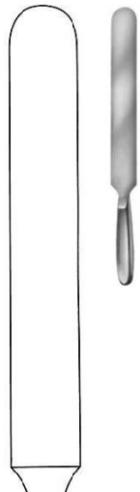

Virchow
AC-5-105-20
Brain Knife with hollow handle
28.5 cm, 33.5 cm, 38 cm,



AC-5-108-04
Scalpel Handle solid
13.5 cm,



AC-5-109-34
Scalpel Handle
16 cm,

Scalpels



AC-5-110-41
Scalpel Handle solid, long
21 cm,



AC-5-111-45
Scalpel Handle
21 cm,



Collin
AC-5-112-08
Scalpel Handle with hollow handle
13.5 cm,



Collin
AC-5-113-09
Scalpel Handle with hollow handle
14.5 cm,



AC-5-114-03
Scalpel Handle solid
12 cm,



AC-5-115-04
Scalpel Handle
12 cm,



Scalpels



AC-5-116-05
Scalpel Handle
12 cm,



AC-5-117-31
Scalpel Handle solid, long
21.5 cm,



AC-5-118-35
Scalpel Handle
21 cm,



AC-5-119-07
Scalpel Handle solid
16 cm,



AC-5-120-71
Scalpel Handle solid short
12.5 cm,



AC-5-121-03
Scalpel Handle with round hollow handle
15.5 cm,



Scalpels



AC-5-127-16
Amputation Knife with hollow handle
29 cm,



AC-5-128-19
Amputation Knife with hollow handle
32.5 cm,



Catlin
AC-5-129-16
Interosseous Knife with hollow handle
29cm,



AC-5-130-06
Resection Knife solid handle, dissecting end
18 cm,



Langenbeck
AC-5-131-05
Resection Knife
18 cm,



Langenbeck
AC-5-132-05
Resection Knife
18 cm,

Scalpels



AC-5-133-00
Razor Knife hollow blades on both sides
cutting length 75mm



Schink
AC-5-134-00
Dermatome complete with 2 skin fixing plates
and one blade
31 cm,



Schink
AC-5-135-01
Spare Blade spare blade for KE-05-134-00



Schink
AC-5-136-02
Skin Fixing Plate for KE-05-134-00

Scissors



Standard BL / BL Straight

AC-5-201-13

Operating Scissor Special

12 cm, 13 cm, 14.5 cm, 16.5 cm, 18.5 cm, 20.5 cm,



Standard SH / BL STR

AC-5-202-13

Operating Scissors

12 cm, 13 cm, 14.5 cm, 16.5 cm, 18.5 cm, 20.5 cm,



Standard SH / SH STR

AC-5-204-13

Operating Scissors

12 cm, 13 cm, 14.5 cm, 16.5 cm,



Standard BL / BL Curved

AC-5-205-13

Operating Scissors

12 cm, 13 cm, 14.5 cm, 16.5 cm, 18.5 cm, 20.5 cm,



Standard SH / BL Curved

AC-5-206-13

Operating Scissors

12 cm, 13 cm, 14.5 cm, 16.5 cm, 18.5 cm, 20.5 cm,



Standard SH / SH Curved

AC-5-207-13

Operating Scissors

12 cm, 13 cm, 14.5 cm, 16.5 cm,

Scissors



Standard BL / BL Curved
AC-5-208-14
Operating Scissors delicate
14.5 cm,



Incision Scissor
AC-5-209-14
Operating Scissor
14.5 cm,



Deaver
AC-5-210-14
Operating Scissors



Mayo
AC-5-211-15
Dissecting Scissors
14.5 cm, 15 cm, 17 cm, 23.5 cm, 14.5 cm, 15 cm, 17 cm, 23.5 cm,



Mayo
AC-5-212-23
Dissecting Scissors
23 cm, 22.5 cm, 28 cm,



Mayo-Harrington
AC-5-213-22
Dissecting Scissors
23 cm, 22.5 cm, 28 cm,

Scissors

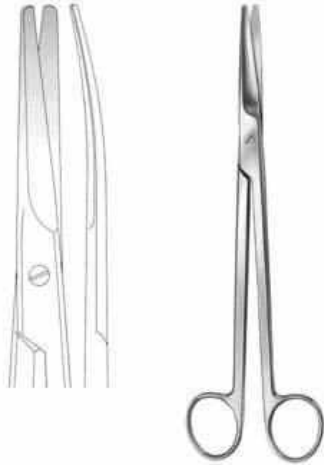

Mayo-Harrington
AC-5-214-22
Dissecting Scissors cur.
22.5 cm, 28 cm, 23 cm,

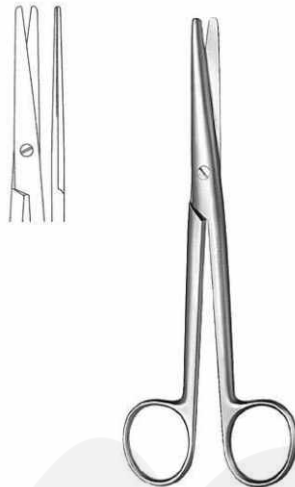

Mayo-Stille
AC-5-215-17
Dissecting Scissors str.
15 cm, 17 cm,

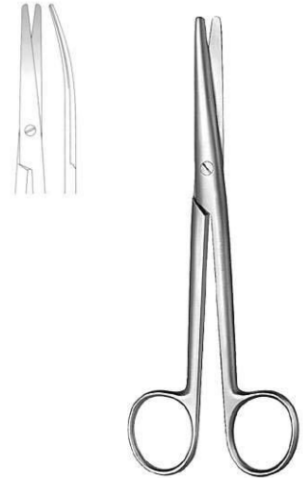

Mayo-Stille
AC-5-216-15
Dissecting Scissors cur.
15 cm, 17 cm,

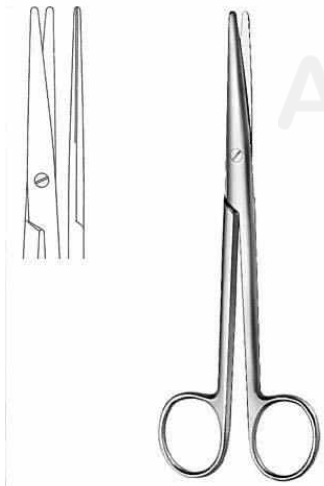

Mayo-Stille
AC-5-217-19
Dissecting Scissors str.
16 cm, 19.5 cm, 21.5 cm,

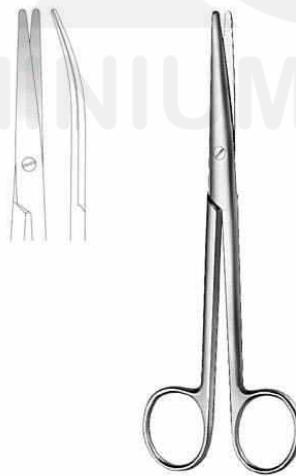

Mayo-Stille
AC-5-218-16
Dissecting Scissors cur.
16 cm, 19.5 cm, 21.5 cm,



Mayo-Noble
AC-5-219-17
Gynecological Scissors
16.5 cm,

Scissors



Sims
AC-5-220-23
Gynecological Scissors str.
20 cm, 23 cm,



Sims
AC-5-221-20
Gynecological Scissors cur.
20 cm, 23 cm,



Kelly
AC-5-222-16
Operating Scissors
16 cm,



Doyen
AC-5-223-17
Gynecological Scissors
18.5 cm,



Sims-Siebold
AC-5-224-24
Gynecological Scissors
24.5 cm,



Sims-Siebold
AC-5-225-24
Gynecological Scissors
24.5 cm,

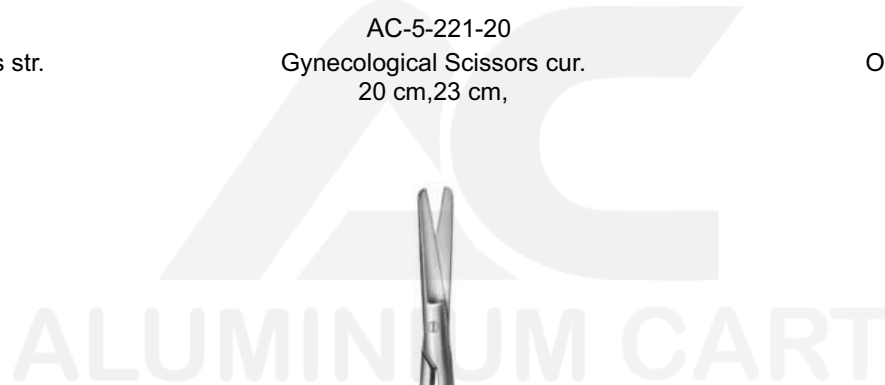

Scissors



Wertheim
AC-5-226-23
Gynecological Scissors
20 cm, 23 cm,



Metzenbaum
AC-5-227-11
Dissecting Scissors
11.5 cm,



Metzenbaum
AC-5-228-14
Dissecting Scissors
14.5 cm,



Metzenbaum
AC-5-229-15
Dissecting Scissors
15.5 cm,



Metzenbaum-Nelson
AC-5-230-20
Dissecting Scissors
18 cm, 20.5 cm, 23 cm, 26 cm, 28.5 cm, 31 cm,



Metzenbaum-Nelson
AC-5-231-20
Dissecting Scissors
18 cm, 20.5 cm,

Scissors



Lexer
AC-5-238-16
Dissecting Scissors
16 cm,



Cinelli
AC-5-239-14
Nasal Scissors
11.5 cm, 14 cm,



Thorek
AC-5-240-19
Dissecting Scissors
18.5 cm,



Lexer-Baby
AC-5-241-10
Dissecting Scissors
10 cm,



Lexer-Fino
AC-5-242-16
Delicate Dissecting Scissors slender pattern
16.5 cm,



Metzenbaum-Fino
AC-5-243-14
Delicate Dissecting Scissors slender pattern
14.5 cm,

Scissors



Metzenbaum-Nelson
AC-5-232-20
Dissecting Scissors
18 cm, 20.5 cm, 23 cm, 26 cm, 28.5 cm, 31 cm,



Metzenbaum
AC-5-233-14
Dissecting Scissors toothed
14.5 cm,



Nerve Operating Scissor
AC-5-234-15
Dissecting Scissors
15.5 cm,

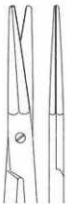

Gorney
AC-5-235-19
Face-lift Scissors str.
12.5 cm, 19.5 cm,



Gorney
AC-5-236-19
Face-lift Scissors cur.
19.5 cm,



Aston
AC-5-237-17
Face-lift Scissors
17 cm,

ALUMINIUM CART

Scissors



Metzenbaum-Fino
AC-5-244-14
Delicate Dissecting Scissors
14.5 cm,



Metzenbaum-Fino
AC-5-245-14
Delicate Dissecting Scissors
14.5 cm,



Metzenbaum-Fino
AC-5-246-14
Delicate Dissecting Scissors
14.5 cm,

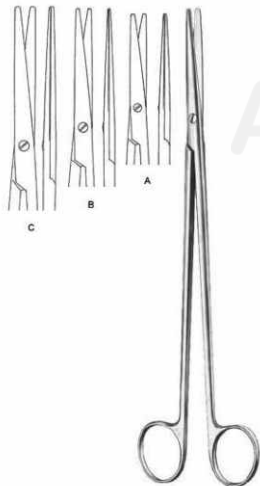

Metzenbaum-Fino
AC-5-247-18
Delicate Dissecting Scissors slender pattern
18 cm, 20 cm, 23 cm,

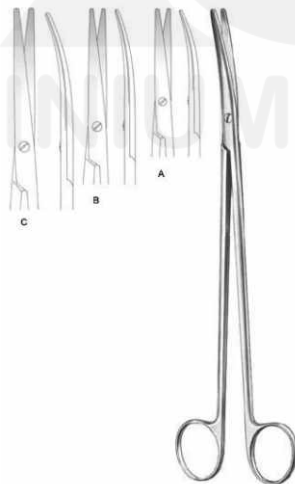

Metzenbaum-Fino
AC-5-248-18
Delicate Dissecting Scissors slender pattern
18 cm, 20 cm, 23 cm,

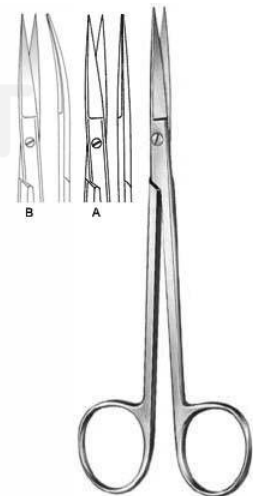

Sanvenero
AC-5-250-14
Operating Scissors
14 cm,

Scissors

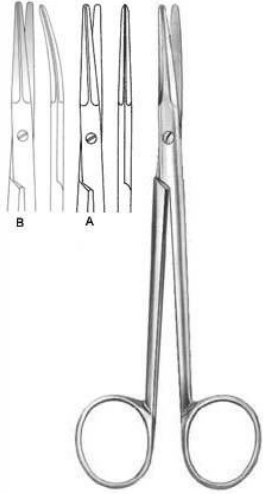

AC-5-257-14
Dissecting Scissors
14.5 cm,

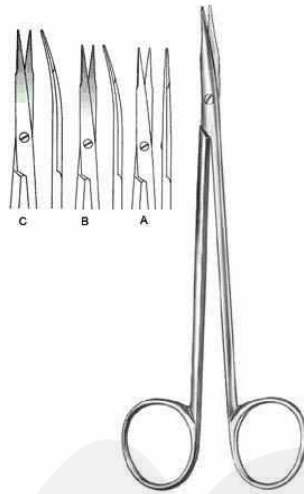

Reynolds
AC-5-258-15
Dissecting Scissors
15.5 cm, 18 cm,



Jameson
AC-5-259-14
Dissecting Scissors
15.5 cm,



Jameson
AC-5-260-14
Dissecting Scissors
15.5 cm,



AC-5-261-19
Vascular Scissors
19 cm,

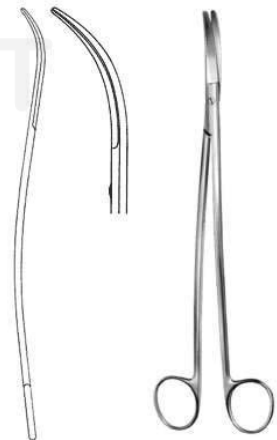

AC-5-262-24
Vascular Scissors fine, short blades
19 cm, 25.5 cm,

Scissors

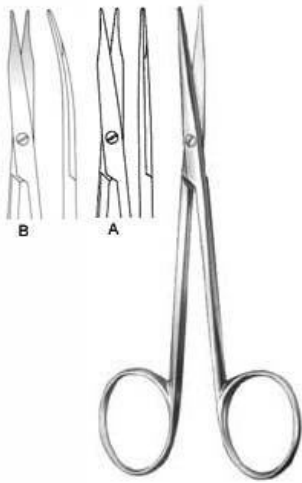

AC-5-251-11
Fine Operating Scissors
11.5 cm,

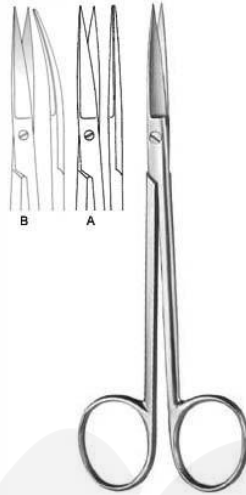

Joseph
AC-5-252-14
Operating Scissors
14.5 cm,

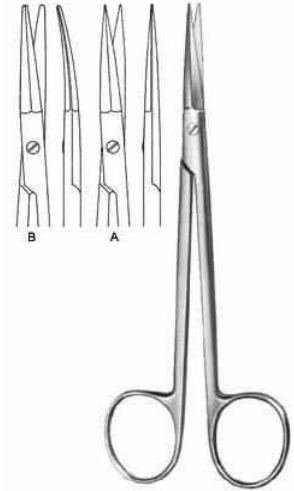

Peck-Joseph
AC-5-253-14
Face-lift Scissors
14.5 cm,

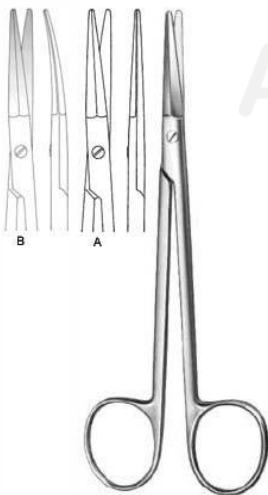

Peck-Joseph
AC-5-254-14
Face-lift Scissors
14.5 cm,



Shea Vein Graft
AC-5-255-12
Dissecting Scissors
12 cm,

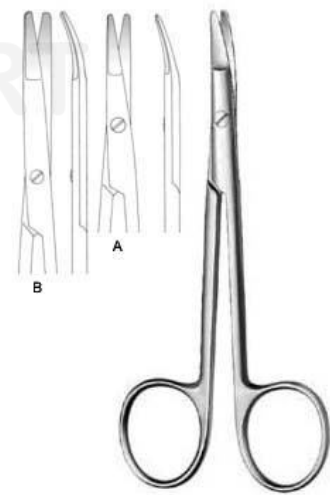

Kilner
AC-5-256-12
Dissecting Scissors
12 cm, 15 cm,

Scissors

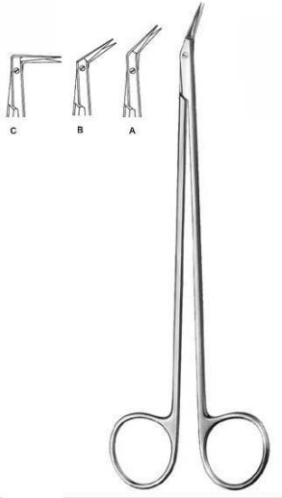

Diethrich
AC-5-263-25
Vascular Scissors
19 cm, 18.5 cm, 17.5 cm,

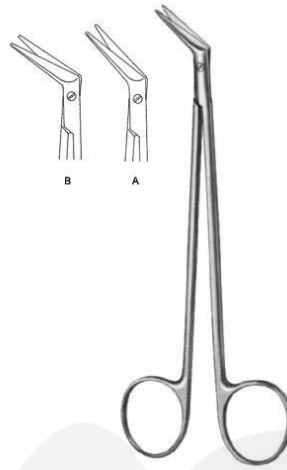

DeBakey
AC-5-264-45
Vascular Scissors
16.5 cm, 16 cm,

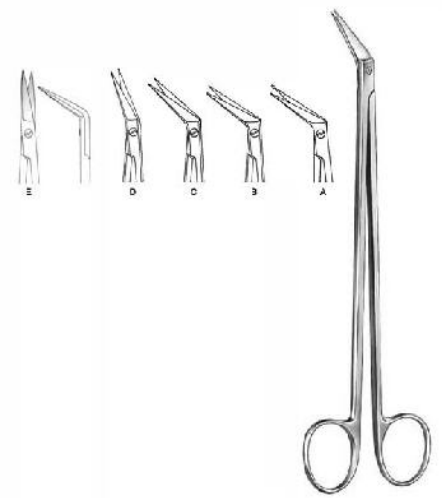

Potts-Smith
AC-5-265-19
Vascular Scissors
18 cm, 18.5 cm, 19 cm,



Coronary Scissors
AC-5-266-25
Cardiovascular Surgery Scissor
18 cm,



Coronary Scissors
AC-5-267-45
Cardiovascular Surgery Scissors
18 cm,



Coronary Scissors
AC-5-268-60
Cardiovascular Surgery Scissor
18 cm,

Scissors

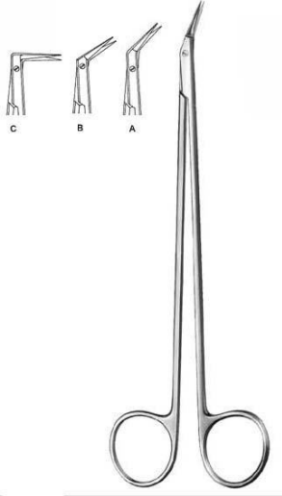

Diethrich
AC-5-263-25
Vascular Scissors
19 cm, 18.5 cm, 17.5 cm,

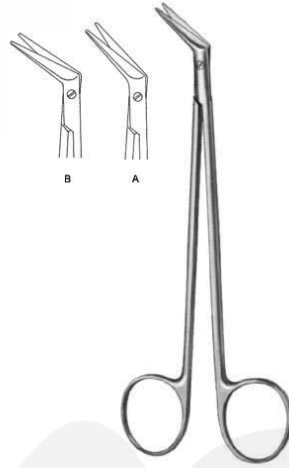

DeBakey
AC-5-264-45
Vascular Scissors
16.5 cm, 16 cm,

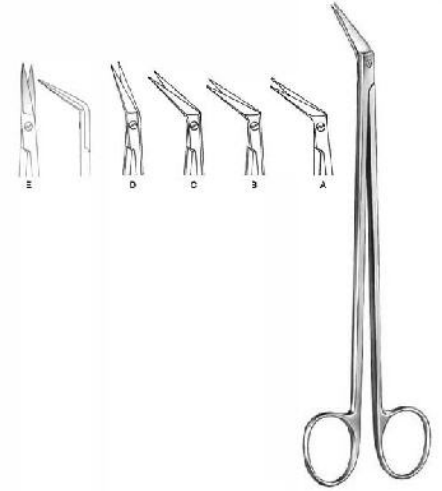

Potts-Smith
AC-5-265-19
Vascular Scissors
18 cm, 18.5 cm, 19 cm,



Coronary Scissors
AC-5-266-25
Cardiovascular Surgery Scissor
18 cm,



Coronary Scissors
AC-5-267-45
Cardiovascular Surgery Scissors
18 cm,



Coronary Scissors
AC-5-268-60
Cardiovascular Surgery Scissor
18 cm,

Scissors



Coronary Scissors
AC-5-269-90
Cardiovascular Surgery Scissor
18 cm,



Coronary Scissors
AC-5-270-00
Cardiovascular Surgery Scissor
18 cm,



Coronary Scissors
AC-5-271-00
Cardiovascular Surgery Scissor
18 cm,



Coronary Scissors
AC-5-272-25
Cardiovascular Surgery Scissor
18 cm,



Coronary Scissors
AC-5-273-45
Cardiovascular Surgery Scissor
18 cm,



Coronary Scissors
AC-5-274-90
Cardiovascular Surgery Scissor
18 cm,

Scissors



Coronary Scissors
AC-5-269-90
Cardiovascular Surgery Scissor
18 cm,



Coronary Scissors
AC-5-270-00
Cardiovascular Surgery Scissor
18 cm,



Coronary Scissors
AC-5-271-00
Cardiovascular Surgery Scissor
18 cm,



Coronary Scissors
AC-5-272-25
Cardiovascular Surgery Scissor
18 cm,



Coronary Scissors
AC-5-273-45
Cardiovascular Surgery Scissor
18 cm,



Coronary Scissors
AC-5-274-90
Cardiovascular Surgery Scissor
18 cm,

Scissors



Schmieden-Taylor
AC-5-275-17
Dura Scissors
15 cm,



Strully
AC-5-276-22
Neurosurgical Scissors
22.5 cm,



Toennis-Adson
AC-5-277-17
Dissecting Scissors
17.5 cm,



Good
AC-5-279-19
Tonsil Scissors
19.5 cm,



Fomon
AC-5-282-15
Nasal Scissors
15 cm,



Cottle
AC-5-283-16
Nasal Scissors
16 cm,

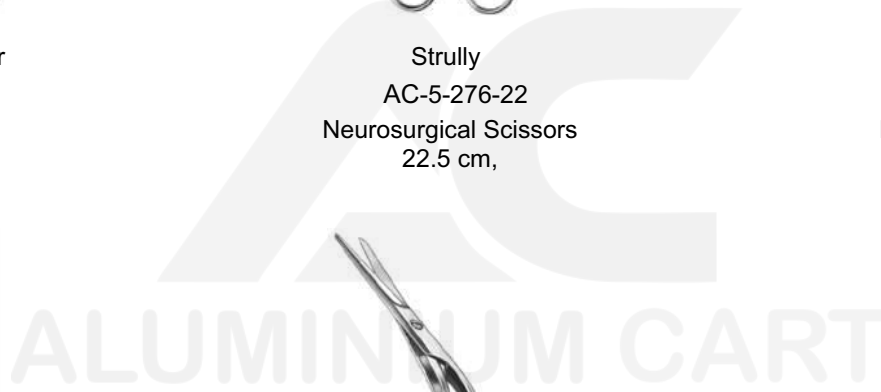

Scissors



Heymann
AC-5-284-18
Nasal Scissors
18.5 cm,



Heymann
AC-5-285-18
Nasal Scissors
18.5 cm,



Converse
AC-5-286-11
Nasal Scissors blunt & sharp
10.5 cm,



Waldmann
AC-5-287-18
Episiotomy Scissors
18 cm,



Braun-Stadler
AC-5-288-14
Episiotomy Scissors
14.5 cm,



Braun-Stadler
AC-5-289-22
Episiotomy Scissors
22 cm,



Scissors



Modell USA
AC-5-290-10
Umbilical Scissors
10.5 cm,



Busch
AC-5-292-16
Umbilical Scissors
16 cm,



Goldmann-Fox
AC-5-293-13
Gum Scissors
13 cm,



Wagner
AC-5-294-12
Operating Scissors
12 cm,

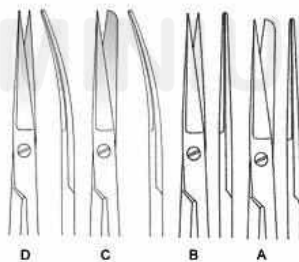

AC-5-295-12
Operating Scissors small model
12 cm,

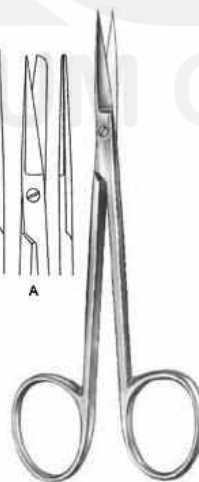

La Grange
AC-5-296-11
Gum Scissors S-shaped
11.5 cm,

Scissors



AC-5-297-11
Dissecting Scissors delicate
11.5 cm,



Locklin
AC-5-298-16
Gum Scissors
16 cm,



Locklin
AC-5-299-16
Gum Scissors
16 cm,



AC-5-300-08
Operating Scissors very delicate
9 cm,

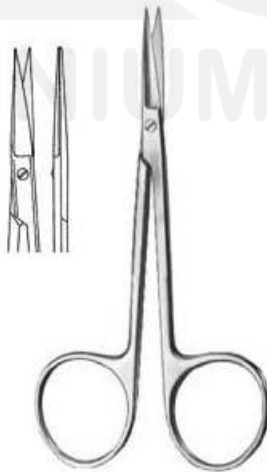

AC-5-301-10
Iris Scissors
9 cm, 10 cm,

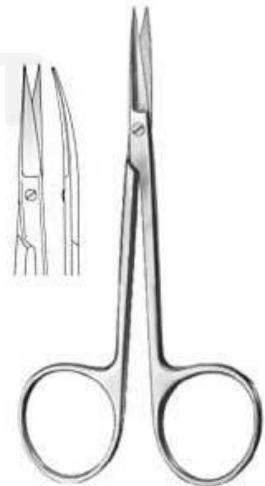

AC-5-302-10
Iris Scissors extra flat blades
10 cm,

Dressing & Tissue Forceps



Standard
AC-5-401-10
Dressing Forceps
10.5 cm, 11.5 cm, 13 cm, 14.5 cm, 16 cm, 18 cm, 20 cm, 23 cm, 25 cm, 30.5 cm,



Standard
AC-5-402-11
Dressing Forceps
12 cm, 13 cm, 14.5 cm, 16 cm, 18 cm, 20 cm, 25 cm, 30 cm,



AC-5-403-13
Dressing Forceps
13 cm, 14.5 cm,



Stille
AC-5-404-15
Dressing Forceps
15 cm,



Mini-Adson
AC-5-405-12
Dressing Forceps
12 cm,



Adson
AC-5-406-12
Dressing Forceps
12 cm, 15 cm,

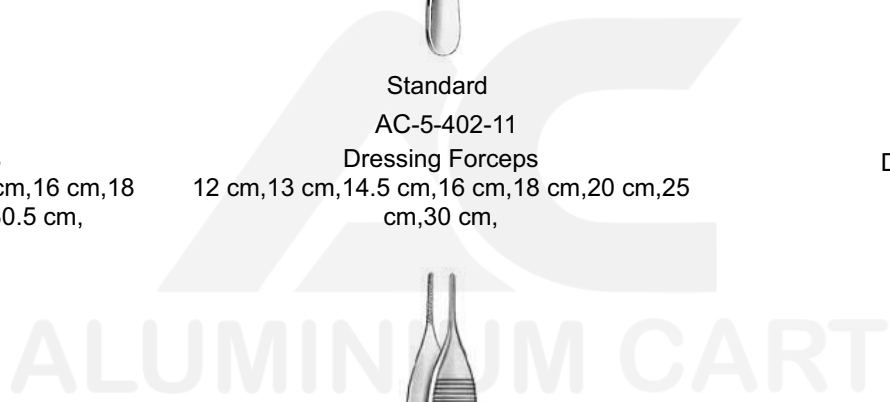

Dressing & Tissue Forceps



McIndoe
AC-5-407-15
Dressing Forceps
15 cm,



Waugh
AC-5-408-20
Dressing Forceps
20 cm,



Semken
AC-5-409-12
Dressing Forceps
12.5 cm, 15 cm,



Taylor
AC-5-410-17
Dressing Forceps
12.5 cm, 15 cm,



Taylor
AC-5-411-17
Dressing Forceps
17 cm,



Taylor
AC-5-412-17
Dressing Forceps
18.5 cm,



Dressing & Tissue Forceps



AC-5-413-06
Micro Dressing Forceps
15.5 cm,



Gerald
AC-5-414-18
Dressing Forceps
15.5 cm,



Cushing
AC-5-415-17
Dressing Forceps
17.5 cm,



Potts-Smith
AC-5-416-18
Dressing Forceps
18 cm, 21 cm, 24.5 cm,



Bonney
AC-5-417-17
Dissecting Forceps
17.5 cm,



Gerald
AC-5-418-17
Dissecting Forceps
17.5 cm,

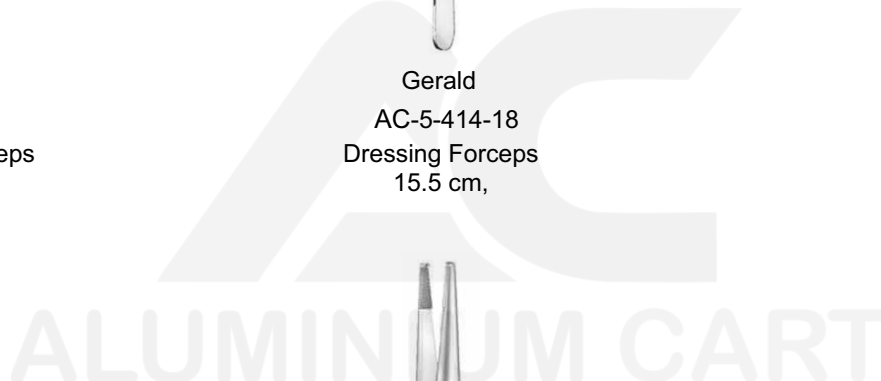

Dressing & Tissue Forceps



Gillies
AC-5-419-15
Dissecting Forceps
15.5 cm,



McIndoe
AC-5-420-15
Dressing Forceps
15 cm,



Semken
AC-5-421-16
Dissecting Forceps
15.5 cm, 17.5 cm,



Adson-Brown
AC-5-422-12
Dissecting Forceps
12 cm,



Adson
AC-5-423-12
Dissecting Forceps
12 cm, 15 cm,



Adson
AC-5-424-12
Dressing Forceps
12 cm, 15 cm,



Scissors



AC-5-303-10
Iris Scissors extra flat blades
10 cm,



Bonn
AC-5-304-09
Iris Scissors



Dean
AC-5-278-17
Tonsil Scissors
17.5 cm,



Spencer Scissor
AC-5-278-18

ALUMINIUM CART

Dressing & Tissue Forceps



Cushing
AC-5-425-17
Dressing Forceps
17.5 cm,



Cushing
AC-5-426-18
Dressing Forceps
17 cm,



Cushing-Taylor
AC-5-427-18
Dressing Forceps
18.5 cm,



Potts-Smith
AC-5-428-15
Dressing Forceps
16 cm, 18.5 cm, 20 cm, 23 cm, 25 cm,



Oehler
AC-5-429-14
Dissecting Forceps
14.5 cm, 16 cm, 18 cm, 20 cm, 25 cm,



Wangensteen
AC-5-430-15
Dressing Forceps
15 cm, 23 cm,

Dressing & Tissue Forceps



DeBakey
AC-5-431-15
Atraumatic Dressing Forceps
16 cm, 20 cm, 24.5 cm, 16 cm, 20 cm, 24.5 cm,



DeBakey
AC-5-432-16
Atraumatic Dressing Forceps
16 cm, 20 cm, 24 cm,

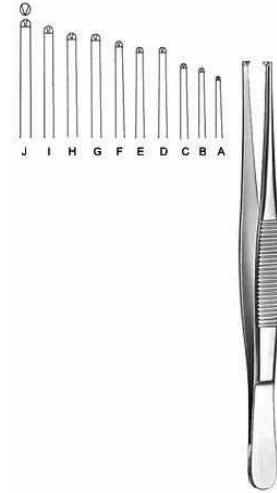

AC-5-433-10
Dissecting Forceps
10.5 cm, 11.5 cm, 13 cm, 14.5 cm, 16 cm, 18 cm, 20 cm, 23 cm, 25 cm, 30.5 cm,

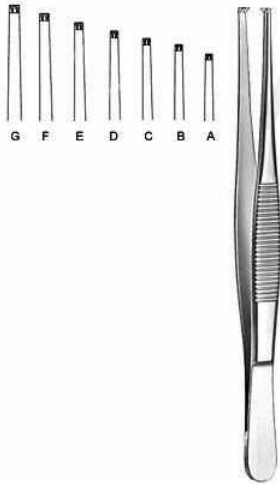

AC-5-434-11
Dissecting Forceps
12 cm, 13 cm, 14.5 cm, 15.5 cm, 18 cm, 20 cm, 24.5 cm,



AC-5-435-14
Dissecting Forceps
14.5 cm, 16 cm,



AC-5-436-14
Dissecting Forceps
14.5 cm, 16 cm,

Dressing & Tissue Forceps



AC-5-437-13
Dissecting Forceps
13 cm, 14.5 cm, 16 cm, 20 cm,



AC-5-438-13
Dissecting Forceps
13 cm, 14.5 cm,



Stille
AC-5-439-15
Dissecting Forceps
15 cm,



Stille
AC-5-440-15
Dissecting Forceps
15 cm,



Stone
AC-5-441-15
Dissecting Forceps
15 cm,



Lerche
AC-5-442-15
Dissecting Forceps
15 cm,



Dressing & Tissue Forceps

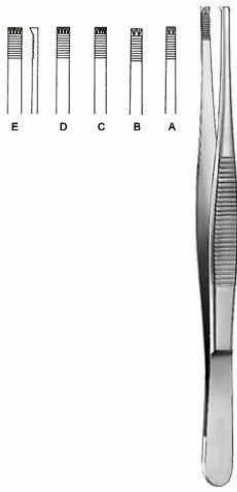

Adlerkreutz
AC-5-443-15
Dissecting Forceps
15.5 cm, 20.5 cm, 16 cm, 20 cm, 25 cm,

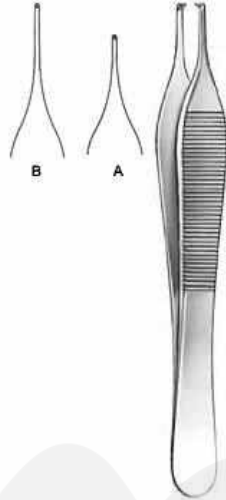

Adson
AC-5-444-12
Dissecting Forceps
12 cm, 15 cm,



Gillies
AC-5-445-15
Dissecting Forceps
15.5 cm,



Waugh
AC-5-446-20
Dissecting Forceps
20.5 cm,



Semken
AC-5-447-12
Dissecting Forceps
12.5 cm, 15 cm,



Taylor
AC-5-448-17
Dissecting Forceps
17.5 cm,

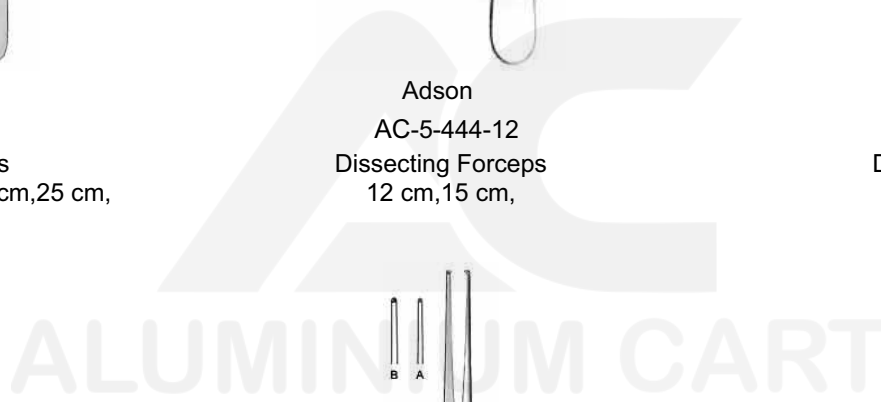

Dressing & Tissue Forceps



Taylor
AC-5-449-17
Dissecting Forceps
17 cm,



Taylor
AC-5-450-17
Dissecting Forceps
18.5 cm,



AC-5-451-06
Micro Dissecting Forceps
15.5 cm,



Gerald
AC-5-452-17
Dissecting Forceps
17.5 cm,



Cushing
AC-5-453-17
Dissecting Forceps
18 cm,



Potts-Smith
AC-5-454-18
Dissecting Forceps
18 cm, 21 cm, 24 cm,

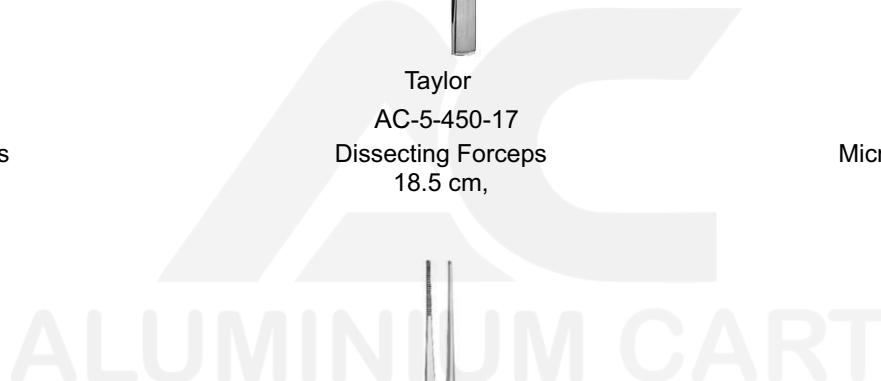

Dressing & Tissue Forceps

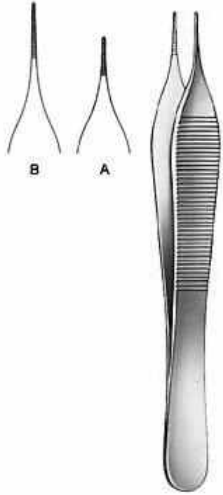

Mikro-Adson
AC-5-455-12
Dressing Forceps
12 cm, 15 cm,

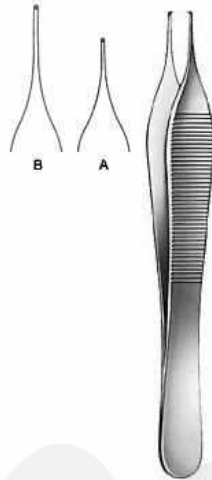

Mikro-Adson
AC-5-456-12
Dissecting Forceps
12 cm, 15 cm,



AC-5-457-11
Dissecting Forceps
10.5 cm,



Micro Jewelers
AC-5-458-12
Jeweler Type Forceps
12 cm Fig. 7,



Jewelers
AC-5-459-12
Jeweler Type Forceps
12 cm Fig. 3,



Jewelers
AC-5-460-11
Jeweler Type Forceps
11 cm Fig. 3c,

Dressing & Tissue Forceps



Jewelers
AC-5-461-11
Jeweler Type Forceps
11 cm Fig. 5,



Jewelers
AC-5-462-11
Jeweler Type Forceps
11 cm Fig. 4,



Stille-Barraya
AC-5-463-18
Dissecting Forceps
18 cm,



Bonney
AC-5-464-18
Dissecting Forceps
17.5 cm,



Nelson
AC-5-465-23
Dissecting Forceps
23 cm,



AC-5-466-10
Dressing Forceps
10 cm, 9.5 cm,



Dressing & Tissue Forceps



AC-5-467-12
Splinter Forceps smooth jaw
12.5 cm,



AC-5-468-12
Splinter Forceps smooth jaw
12.5 cm,



AC-5-469-12
Splinter Forceps
12.5 cm,



AC-5-470-12
Splinter Forceps
12.5 cm,



AC-5-471-16
Micro Tying Forceps
15.5 cm,



AC-5-472-10
Microscopic Forceps super light, blunt
10 cm,

Dressing & Tissue Forceps



AC-5-473-10
Microscopic Forceps
10 cm,



Shaaf
AC-5-474-09
Splinter Forceps
9.5 cm,



Littauer
AC-5-475-08
Cilia Forceps
8.5 cm,



AC-5-476-09
Cilia Forceps
8.5 cm,



Douglas
AC-5-477-09
Cilia Forceps
9 cm,



Douglas
AC-5-478-09
Cilia Forceps
9 cm,

Dressing & Tissue Forceps

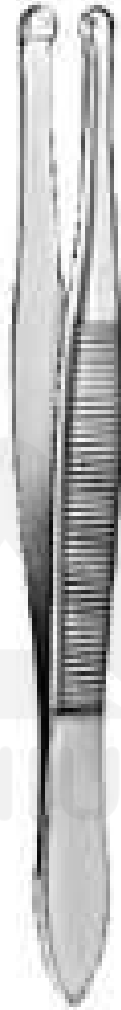

Beer

AC-5-479-09

Cilia Forceps

9 cm,

Splinter Forceps



Phaneuf
AC-5-501-21
Hysterectomy Forceps
20.5 cm,



Wertheim-Cullen
AC-5-502-21
Vaginal Clamp
21 cm,

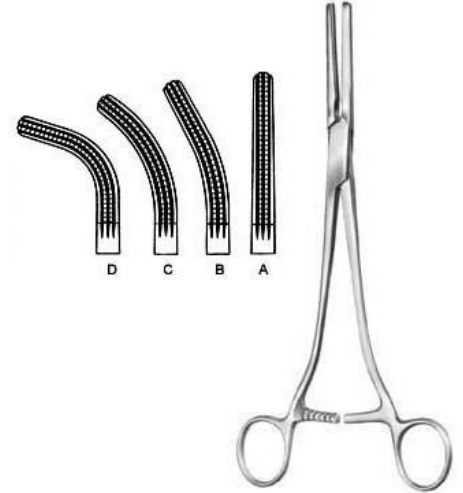

Rogers
AC-5-503-10
Hysterectomy Forceps
21.5 cm Fig. 1, 21 cm Fig. 2, 20.5 cm Fig. 3, 20 cm Fig. 4,



Moynihan
AC-5-504-23
Hysterectomy Forceps
23 cm,



Moynihan
AC-5-505-24
Hysterectomy Forceps
23.5 cm,



Wertheim
AC-5-506-25
Hysterectomy Forceps
26 cm,

ALUMINIUM CART

Splinter Forceps



Phaneuf
AC-5-501-21
Hysterectomy Forceps
20.5 cm,



Werheim-Cullen
AC-5-502-21
Vaginal Clamp
21 cm,

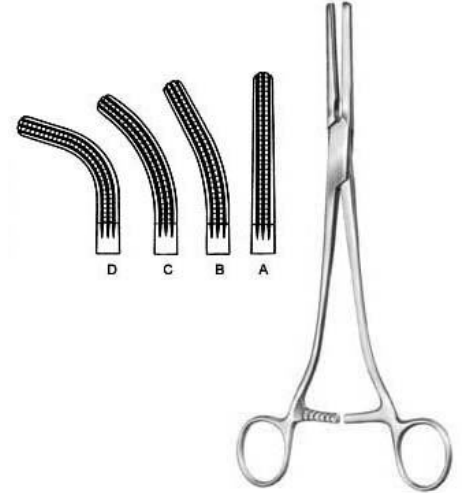

Rogers
AC-5-503-10
Hysterectomy Forceps
21.5 cm Fig. 1, 21 cm Fig. 2, 20.5 cm Fig. 3, 20 cm Fig. 4,



Moynihan
AC-5-504-23
Hysterectomy Forceps
23 cm,



Moynihan
AC-5-505-24
Hysterectomy Forceps
23.5 cm,



Werheim
AC-5-506-25
Hysterectomy Forceps
26 cm,

ALUMINIUM CART

Splinter Forceps

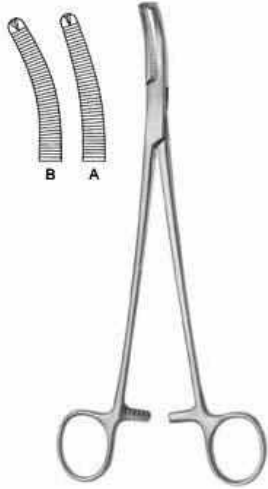

Wertheim
AC-5-507-22
Hysterectomy Forceps
22.5 cm,



Mikulicz, Baby
AC-5-508-14
Peritoneum Forceps
14.5 cm,



Mikulicz
AC-5-509-18
Peritoneum Forceps
20.5 cm,



Mikulicz
AC-5-510-20
Peritoneum Forceps
18.5 cm,



Mikulicz
AC-5-511-20
Peritoneum Forceps
20 cm,



Mikulicz
AC-5-512-21
Peritoneum Forceps
20.5 cm,

Splinter Forceps



Faure

AC-5-513-20

Peritoneum Forceps

21 cm,

Haemostatic Forceps

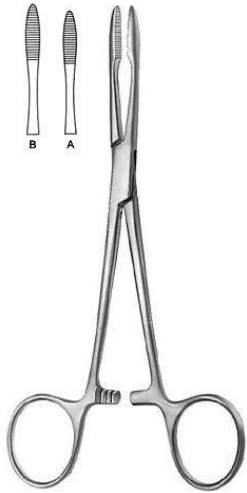

Pean
AC-5-601-14
Haemostatic Forceps
14.5 cm, 16 cm,

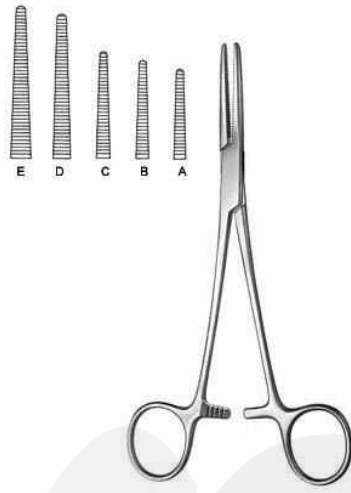

Spencer-Wells
AC-5-602-13
Haemostatic Forceps
13 cm, 14 cm, 15.5 cm, 18.5 cm, 20 cm,

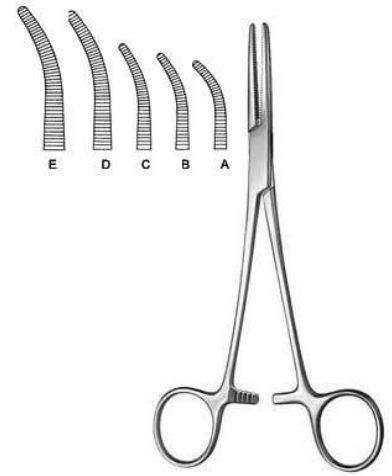

Spencer-Wells
AC-5-603-13
Haemostatic Forceps
13 cm, 14 cm, 15 cm, 18 cm, 20 cm,



Chaput
AC-5-604-13
Haemostatic Forceps



Tuffier
AC-5-605-13
Haemostatic Forceps

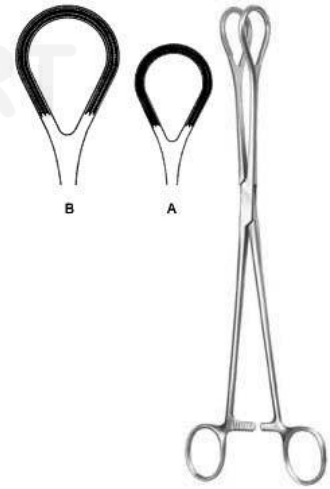

AC-5-606-25
Organ Grasping Forceps

Haemostatic Forceps



Collin
AC-5-607-14
Organ Grasping Forceps
15.5 cm, 21 cm,



Collin
AC-5-608-17
Tumor Grasping Forceps
17 cm,



Pennington
AC-5-609-15
Haemostatic Forceps
15.5 cm,



Pratt
AC-5-610-15
Haemostatic Forceps
15 cm,



Martel-Rees
AC-5-611-14
Face-lift Forceps
13.5 cm,



AC-5-612-12
Ligature Forceps

Haemostatic Forceps

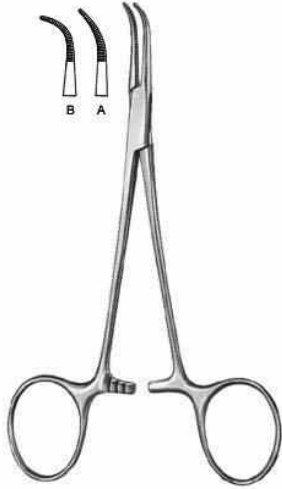

Mixer-Baby
AC-5-613-01
Dissecting and Ligature Forceps
13.5 cm, 13 cm,

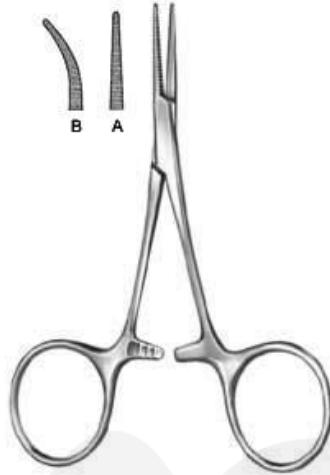

Hartmann
AC-5-614-10
Haemostatic Forceps
10 cm, 9.5 cm,



AC-5-615-12
Ligature Forceps

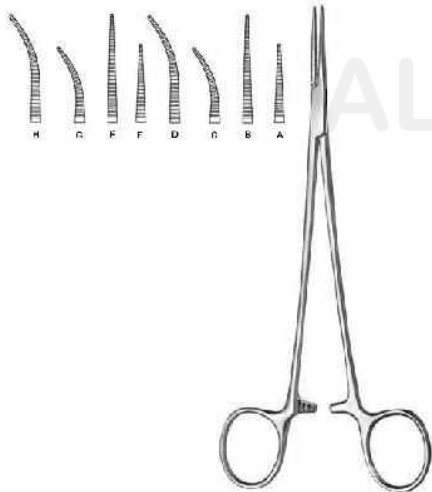

Halsted-Mosquito
AC-5-616-18
Haemostatic Forceps
12.5 cm, 14.5 cm, 14 cm,



Mikro-Mosquito
AC-5-617-10
Haemostatic Forceps
10 cm, 12 cm, 9.5 cm, 11.5 cm,



Providence-Hospital
AC-5-618-14
Haemostatic Forceps
14 cm,

Haemostatic Forceps



Leriche
AC-5-619-15
Haemostatic Forceps
15.5 cm, 15 cm,

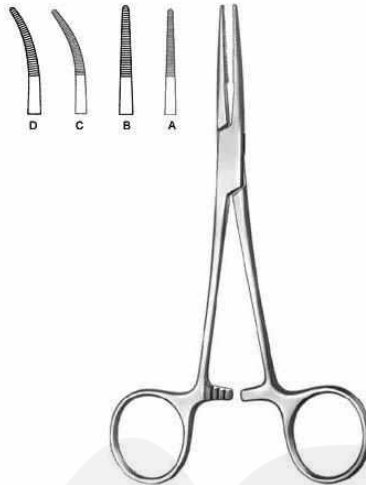

Kelly
AC-5-620-14
Haemostatic Forceps
14.5 cm, 14 cm,

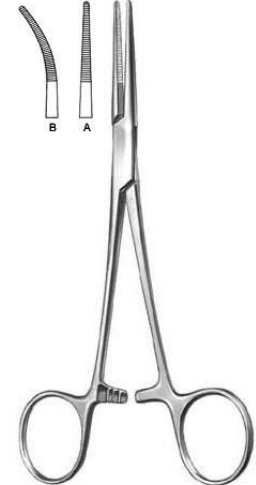

Kelly-Rankin
AC-5-621-16
Haemostatic Forceps
16 cm, 15.5 cm,



Overholt-Baby
AC-5-622-14
Dissecting and Ligature Forceps
14.5 cm, 14 cm,



Crile
AC-5-623-14
Haemostatic Forceps
14.5 cm, 14 cm,



Crile-Rankin
AC-5-624-16
Haemostatic Forceps
16.5 cm, 16 cm,

Haemostatic Forceps

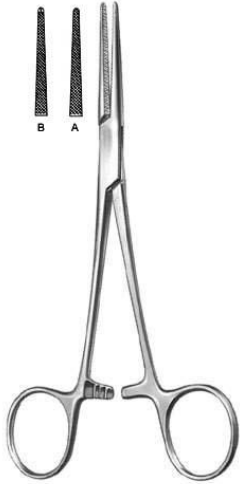

Lovelace
AC-5-625-15
Haemostatic Forceps
16 cm,



Dandy-Mosquito
AC-5-626-12
Haemostatic Forceps
12 cm,

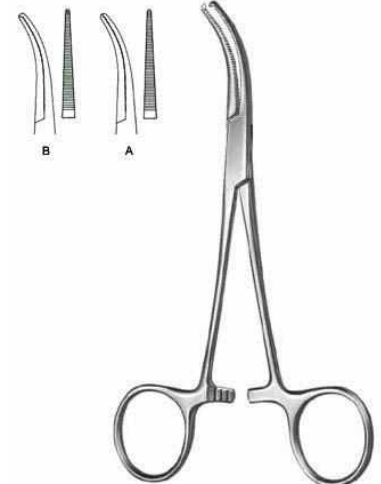

Dandy
AC-5-627-14
Haemostatic Forceps
14.5 cm, 14 cm,



Schidt
AC-5-628-18
Dissecting and Ligature Forceps
18.5 cm, 19 cm,



Adson
AC-5-629-18
Dissecting and Ligature Forceps
19 cm, 18.5 cm,



Martin-Fuchsig
AC-5-630-20
Dissecting and Ligature Forceps
20.5 cm,

Haemostatic Forceps

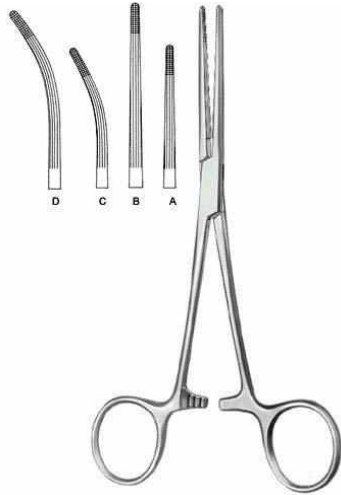

Rochester-Carmalt
AC-5-631-16
Haemostatic Forceps
17 cm, 20.5 cm, 16.5 cm, 20 cm,

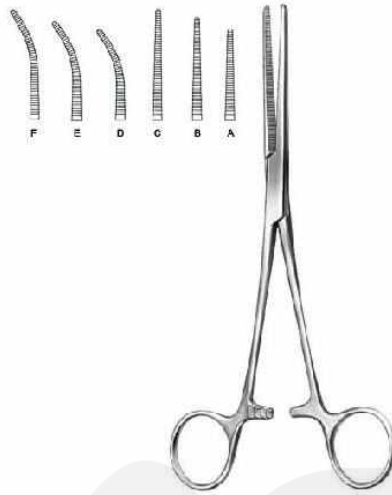

Pean
AC-5-632-13
Haemostatic Forceps
13.5 cm, 14.5 cm, 17 cm, 13 cm, 14 cm, 16.5 cm,

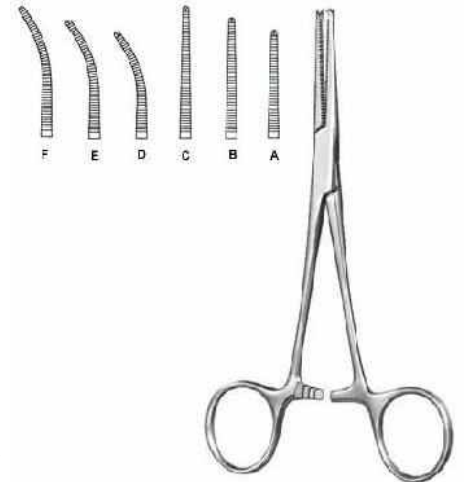

Kocher-Nippon
AC-5-633-14
Haemostatic Forceps
14.5 cm, 16.5 cm, 18.5 cm, 16 cm, 18 cm,

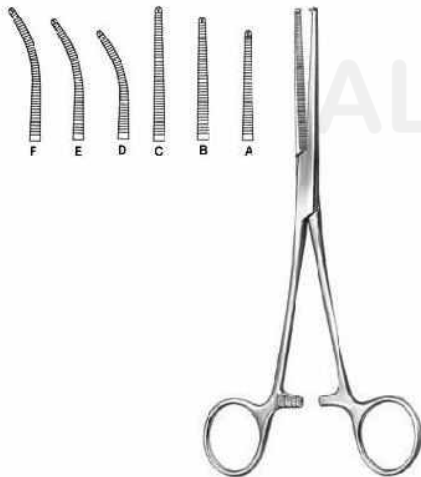

Kocher
AC-5-635-13
Haemostatic Forceps
13 cm, 14 cm, 16 cm,

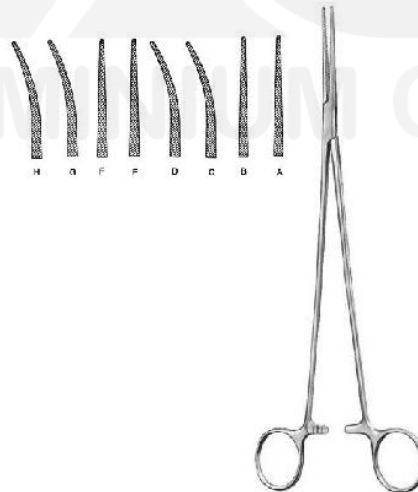

Bengolea
AC-5-636-20
Haemostatic Forceps
21.5 cm, 26 cm, 21 cm, 21.5 cm,

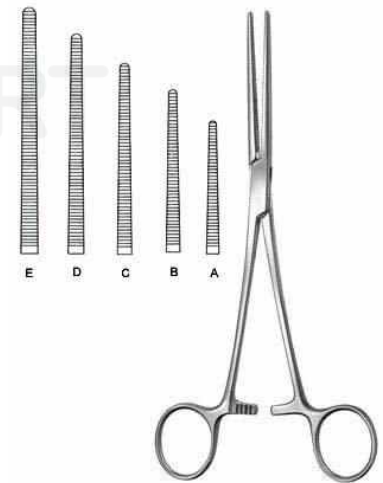

Pean (Rochester)
AC-5-637-14
Haemostatic Forceps
14.5 cm, 16.5 cm, 18.5 cm, 20.5 cm, 22.5 cm, 24.5 cm, 26 cm, 30.5 cm, 14 cm, 16 cm,

Haemostatic Forceps

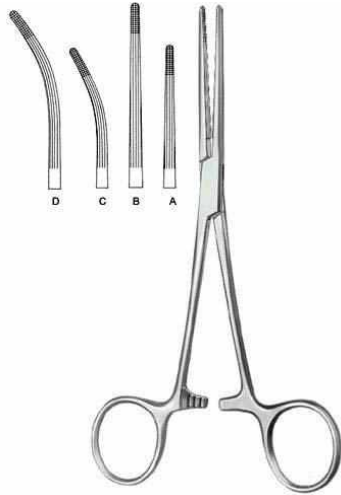

Rochester-Carmalt
AC-5-631-16
Haemostatic Forceps
17 cm, 20.5 cm, 16.5 cm, 20 cm,

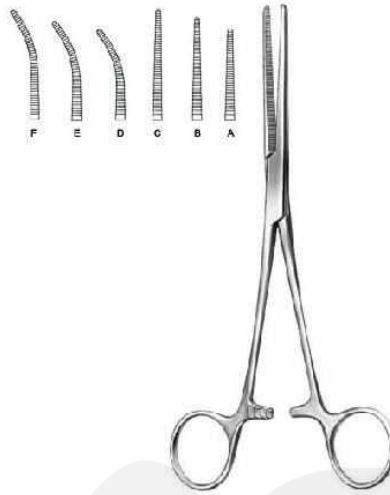

Pean
AC-5-632-13
Haemostatic Forceps
13.5 cm, 14.5 cm, 17 cm, 13 cm, 14 cm, 16.5 cm,

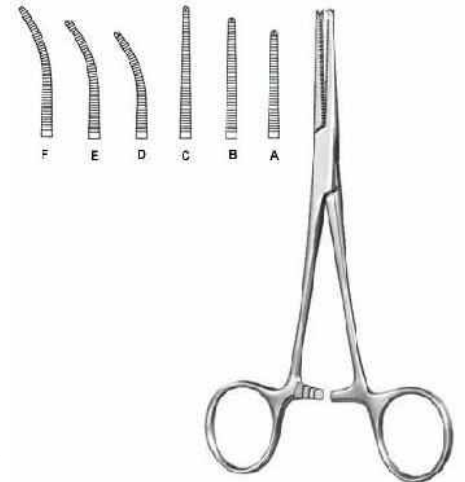

Kocher-Nippon
AC-5-633-14
Haemostatic Forceps
14.5 cm, 16.5 cm, 18.5 cm, 16 cm, 18 cm,

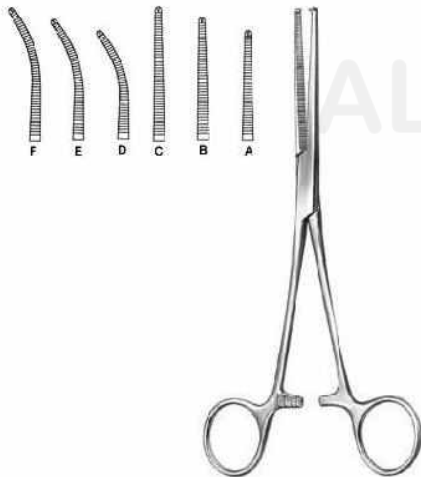

Kocher
AC-5-635-13
Haemostatic Forceps
13 cm, 14 cm, 16 cm,

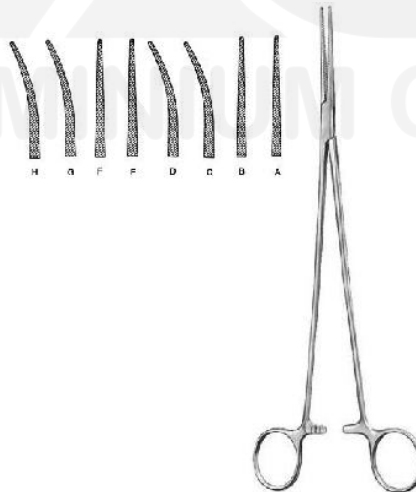

Bengolea
AC-5-636-20
Haemostatic Forceps
21.5 cm, 26 cm, 21 cm, 21.5 cm,

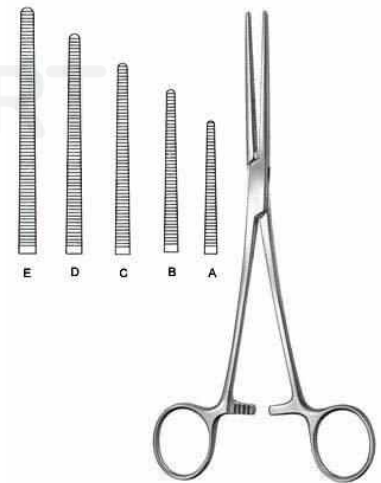

Pean (Rochester)
AC-5-637-14
Haemostatic Forceps
14.5 cm, 16.5 cm, 18.5 cm, 20.5 cm, 22.5 cm, 24.5 cm, 26 cm, 30.5 cm, 14 cm, 16 cm,

Haemostatic Forceps

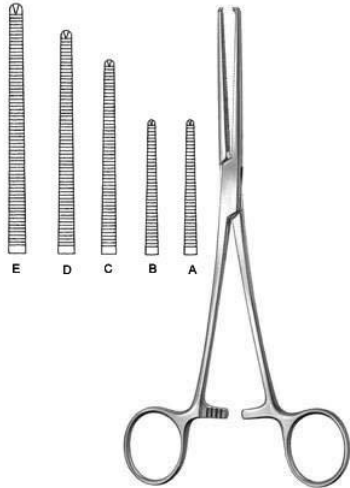

Kocher (Ochsner)
AC-5-638-14

Haemostatic Forceps
14.5 cm, 16.5 cm, 18.5 cm, 20.5 cm, 22.5 cm, 24.5 cm, 26 cm, 30.5 cm,

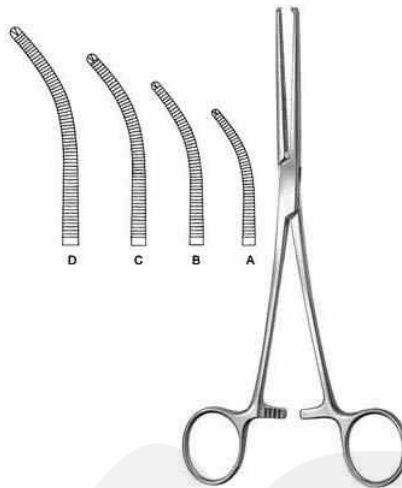

Kocher (Ochsner)
AC-5-639-14

Haemostatic Forceps
14 cm, 16 cm, 18 cm, 20 cm, 22 cm, 24 cm, 25.5 cm, 30 cm,

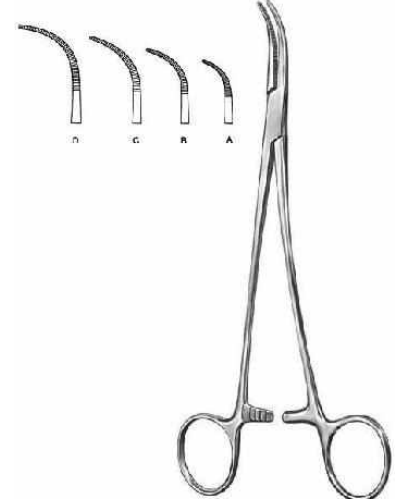

Overholt-Martin
AC-5-640-01

Dissecting and Ligature Forceps
18.5 cm Fig. 1, 20.5 cm Fig. 2, 21 cm Fig. 3, 21.5 cm Fig. 4, 24.5 cm Fig. 5,



Mixer-Baby
AC-5-641-18

Dissecting and Ligature Forceps
18.5 cm,



Adson-Baby
AC-5-642-14

Dissecting and Ligature Forceps
14.5 cm, 18 cm,



Heiss
AC-5-643-20

Dissecting and Ligature Forceps
21 cm, 20.5 cm, 20 cm,

Haemostatic Forceps



Overholt-Mixer
AC-5-644-21
Dissecting and Ligature Forceps
21.5 cm,

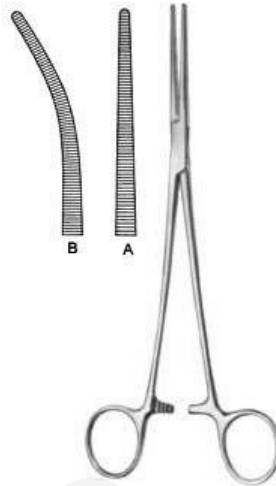

Roberts
AC-5-645-22
Dissecting and Ligature Forceps
22.5 cm, 21.5 cm,

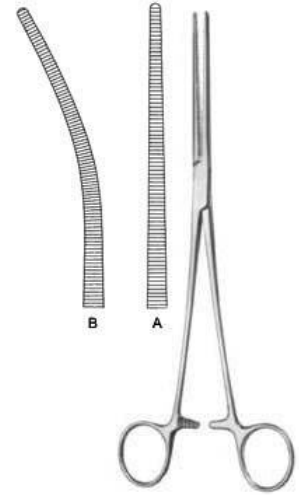

Sarot
AC-5-646-24
Dissecting and Ligature Forceps
25 cm, 24.5 cm,

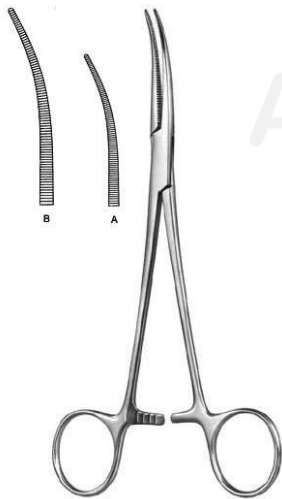

Crafoord
AC-5-647-18
Dissecting and Ligature Forceps
18 cm, 24.5 cm,

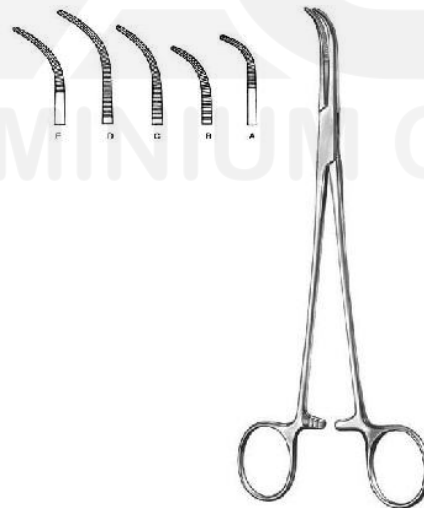

Overholt-Geissendorfer
AC-5-648-01
Dissecting and Ligature Forceps
20.5 cm Fig. 1, 20 cm Fig. 2, 21.5 cm Fig. 3, 22 cm Fig. 4, 21.5 cm Fig. 5, 22 cm Fig. 6, 27 cm Fig. 1, 26.5 cm Fig. 2, 27.5 cm Fig. 3, 28 cm Fig. 4,

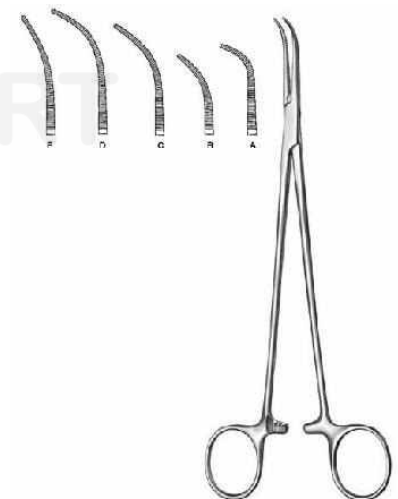

Overholt-Fino
AC-5-649-00
Dissecting and Ligature Forceps
21.5 cm, 21 cm, 22 cm, 23 cm, 22.5 cm,

Haemostatic Forceps

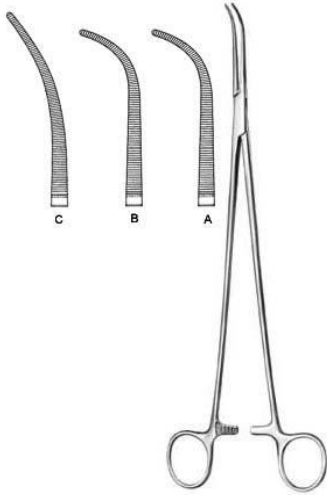

Overholt
AC-5-650-00
Dissecting and Ligature Forceps
29.5 cm, 30 cm,



Overholt-Mini
AC-5-651-01
Dissecting and Ligature Forceps
15 cm, 20 cm,

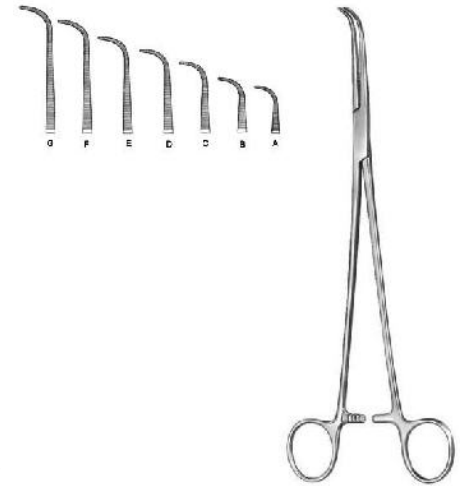

Gemini
AC-5-652-13
Dissecting and Ligature Forceps
13 cm, 16 cm, 18 cm, 21 cm, 23 cm, 25 cm, 28 cm,

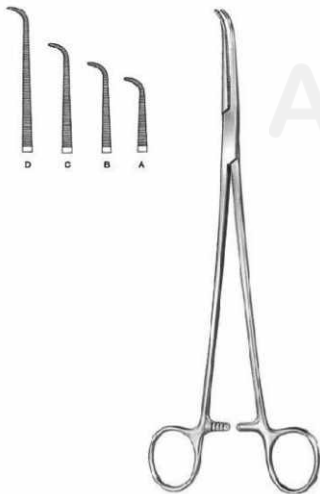

Mini-Gemini
AC-5-653-18
Dissecting and Ligature Forceps
18 cm, 22.5 cm, 25 cm, 28.5 cm,

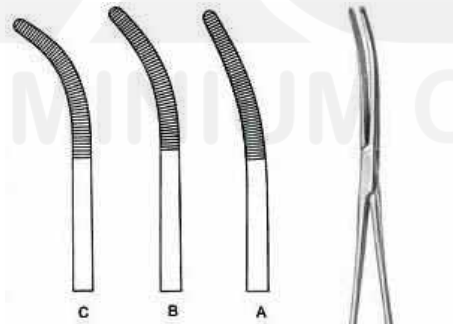

Rumel
AC-5-654-01
Dissecting and Ligature Forceps
24 cm Fig. 1, 23.5 cm Fig. 2, 23 cm Fig. 3, 24 cm Fig. 4, 23.5 cm Fig. 5,

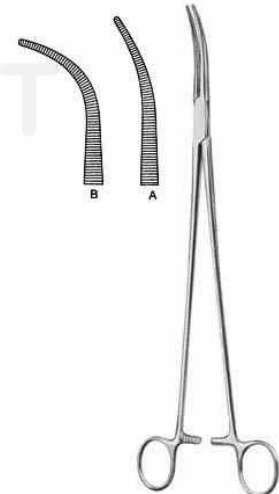

Zenker
AC-5-655-01
Dissecting and Ligature Forceps
29.5 cm, 28.5 cm,

Haemostatic Forceps



Mixer-Baby
AC-5-656-14
Dissecting and Ligature Forceps
13.5 cm,



Mixer
AC-5-657-15
Dissecting and Ligature Forceps
16 cm, 18 cm,



Mixer-O Shaugnessy
AC-5-658-19
Dissecting and Ligature Forceps
18 cm,



Mixer
AC-5-659-22
Dissecting and Ligature Forceps
22.5 cm,



Mixer
AC-5-660-23
Dissecting and Ligature Forceps
23 cm,



Wickstrom
AC-5-661-21
Dissecting and Ligature Forceps
21 cm, 24.5 cm,

ALUMINIUM CART

Haemostatic Forceps



Mixer
AC-5-662-22
Dissecting and Ligature Forceps
22.5 cm, 26 cm, 28 cm,



Mc Quigg-Mixer
AC-5-663-22
Dissecting and Ligature Forceps
23.5 cm,



Lower
AC-5-664-18
Dissecting and Ligature Forceps
18.5 cm,

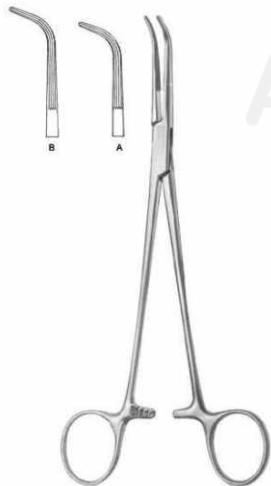

Lahey
AC-5-665-19
Bile Duct Clamp
19.5 cm, 22.5 cm,



Finochietto
AC-5-666-24
Dissecting and Ligature Forceps
24 cm,



Uro-Tangential
AC-5-667-01
Tangential Forceps
25 cm, 27 cm,

Haemostatic Forceps

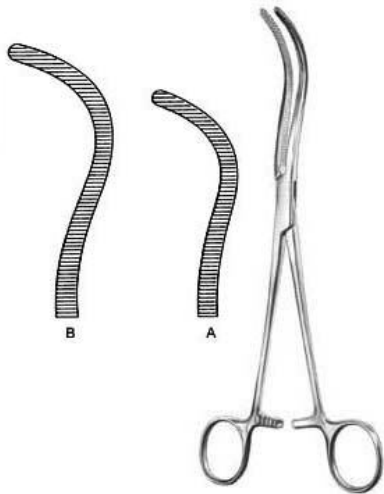

Guyon
AC-5-668-20
Kidney Pedicle Clamp
23 cm, 24 cm,



Guyon
AC-5-669-23
Kidney Pedicle Clamp
19.5 cm, 21.5 cm, 24 cm,



Desjardins
AC-5-670-21
Bile Duct Clamp
21 cm,



Kelly
AC-5-671-19
Dissecting and Ligature Forceps
19.5 cm Fig. 1, 22.5 cm Fig. 1, 24.5 cm Fig. 1,
19 cm Fig. 2, 22 cm Fig. 2, 24 cm Fig. 2, 18.5
cm Fig. 3, 21.5 cm Fig. 3, 23.5 cm Fig. 3,



Lawrence
AC-5-672-28
Dissecting and Ligature Forceps
28 cm,



Meeker
AC-5-673-28
Dissecting and Ligature Forceps
28 cm,

Haemostatic Forceps

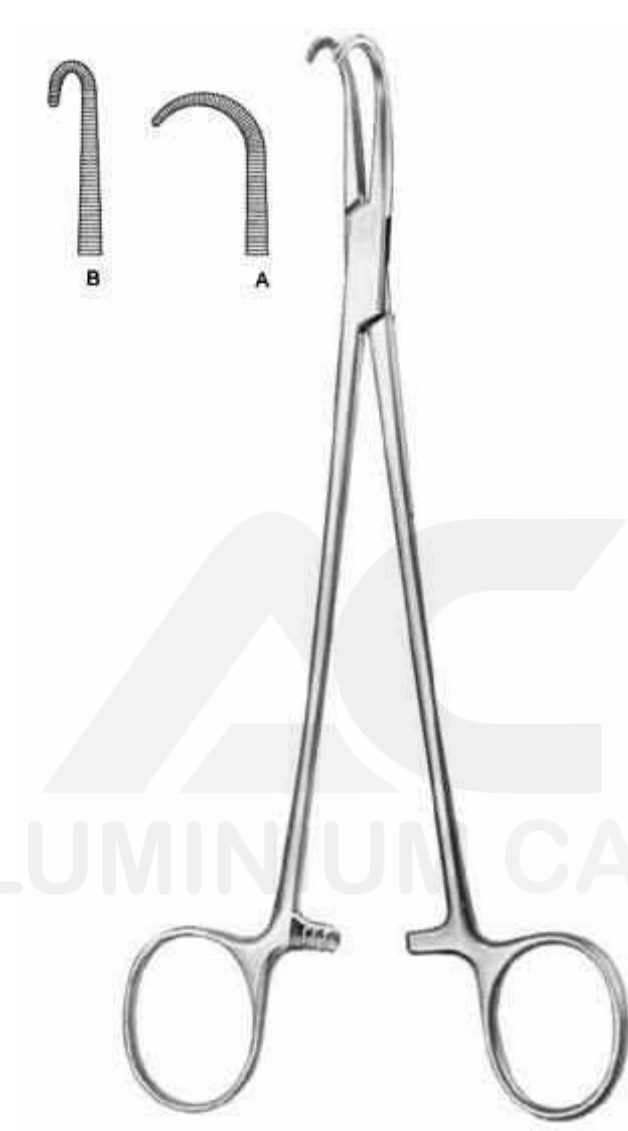

Negus

AC-5-674-19

Haemostatic Forceps

19.5 cm Fig. 1, 20 cm Fig. 2,

Towel & Tubing Clamps



Schaedel
AC-5-701-09
Towel Clamp sharp
9 cm,



Jones
AC-5-702-05
Towel Clamp sharp
5.5 cm, 8.5 cm,



Jones-Martin
AC-5-703-09
Towel Clamp sharp
8.5 cm,

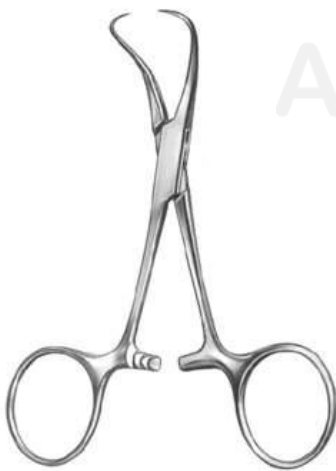

Backhaus
AC-5-704-11
Towel Clamp
11.5 cm, 13 cm,



Backhaus
AC-5-705-11
Towel Clamp
11.5 cm,



Backhaus
AC-5-706-08
Towel Clamp
9 cm, 11.5 cm, 13 cm, 16 cm,

Towel & Tubing Clamps

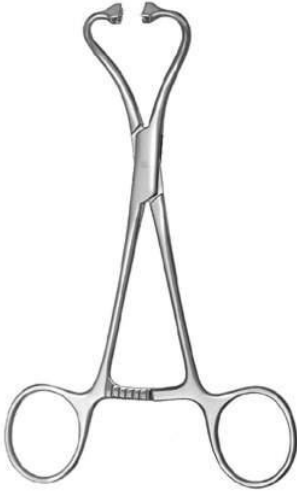

Peers-Bertram modif.
AC-5-707-15
Towel Clamp wide jaw for tube fixation
15.5 cm,



R?der
AC-5-708-13
Towel Clamp
13.5 cm,

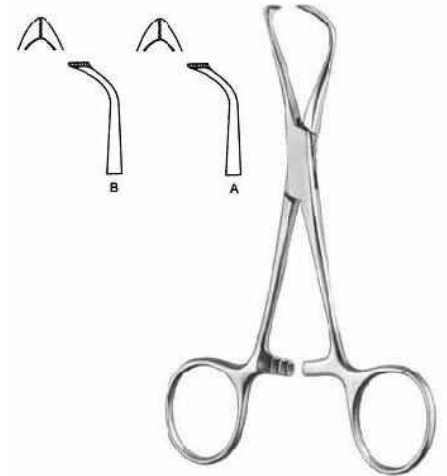

Lorna
AC-5-709-10
Towel Clamp fine serrated, wide jaw
9.5 cm, 13 cm,



Bernhard
AC-5-710-16
Towel Clamp
16.5 cm,

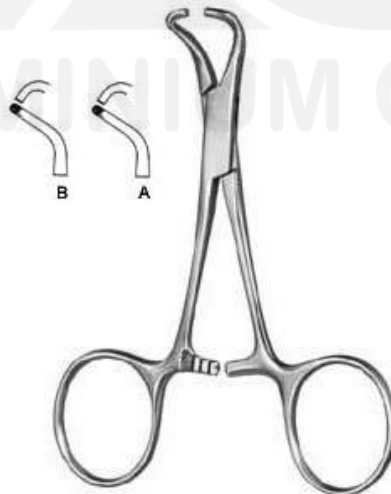

Tohoku
AC-5-711-10
Towel Clamp
10.5 cm blunt, 13.5 cm blunt, 14.5 cm,

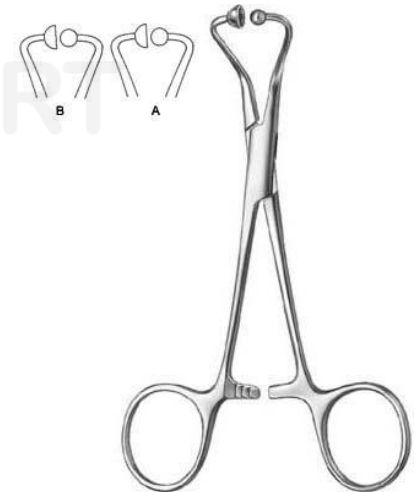

AC-5-712-11
Towel Clamp for paper clothes
11.5 cm, 14 cm,

Towel & Tubing Clamps



Lane
AC-5-713-20
Towel Clamp
19.5 cm,



AC-5-714-06
Tube Holder for fixation of six tubes



AC-5-715-14
Tubing Clamp extra long ratchet
14 cm,



AC-5-716-16
Tubing Clamp
16.5 cm,

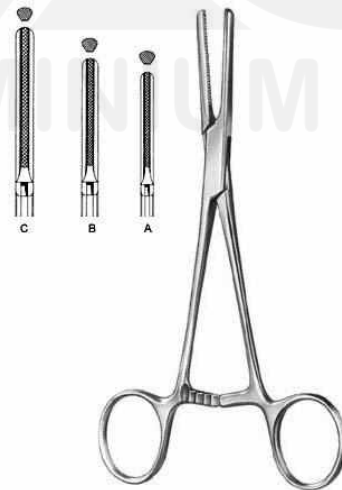

AC-5-717-15
Tubing Clamp
15.5 cm, 19 cm, 20.5 cm,

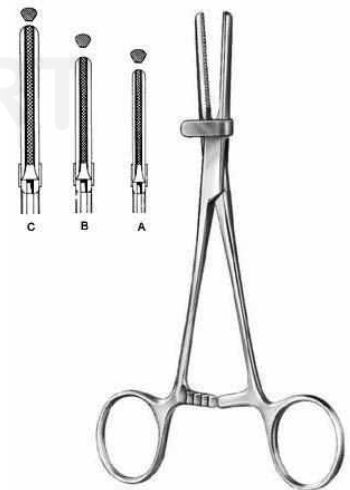

AC-5-718-15
Tubing Clamp with safety guard
15.5 cm, 19 cm, 20.5 cm,

Dressing & Sponge Forceps

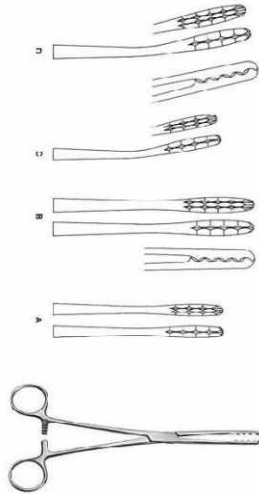

Ulrich
AC-5-801-22
Dressing Forceps
22.5 cm, 26.5 cm,

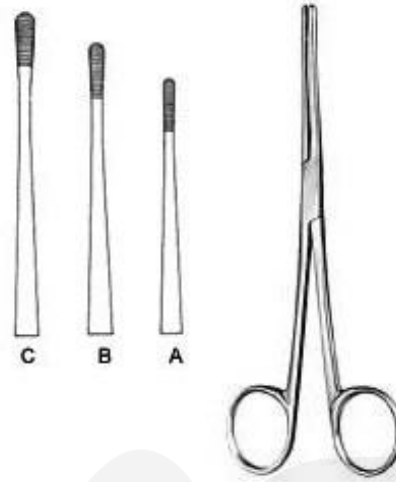

Lister
AC-5-802-13
Sinus Forceps
13 cm, 16 cm, 18 cm,



Martin
AC-5-803-17
Dressing Forceps
17.5 cm, 17 cm,

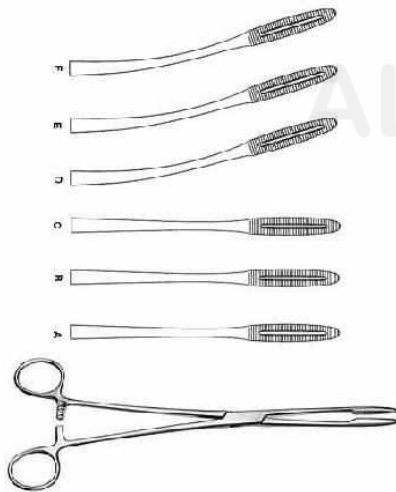

Gross-Maier
AC-5-804-20
Dressing Forceps
20.5 cm, 22 cm, 26.5 cm, 20 cm, 21.5 cm, 26 cm,



AC-5-805-40
Tunneling Forceps
39.5 cm,



Collin
AC-5-806-25
Dressing Forceps
25.5 cm,

Towel & Tubing Clamps



Lane
AC-5-713-20
Towel Clamp
19.5 cm,



AC-5-714-06
Tube Holder for fixation of six tubes



AC-5-715-14
Tubing Clamp extra long ratchet
14 cm,



AC-5-716-16
Tubing Clamp
16.5 cm,

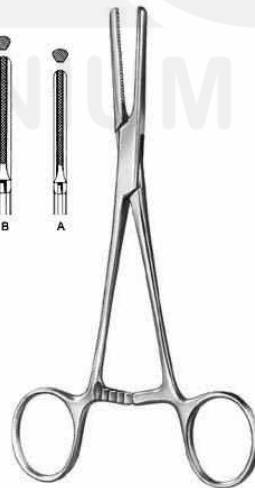
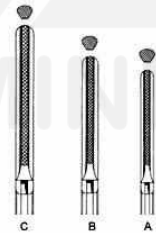

AC-5-717-15
Tubing Clamp
15.5 cm, 19 cm, 20.5 cm,

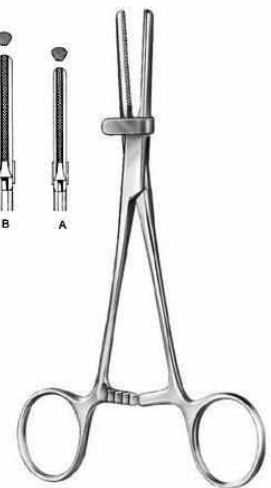

AC-5-718-15
Tubing Clamp with safety guard
15.5 cm, 19 cm, 20.5 cm,

Dressing & Sponge Forceps

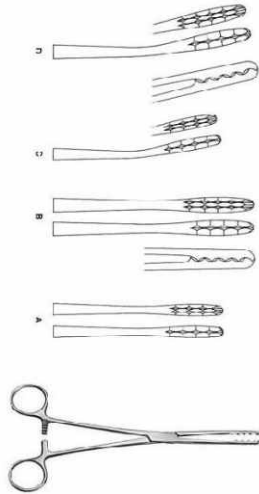

Ulrich
AC-5-801-22
Dressing Forceps
22.5 cm, 26.5 cm,

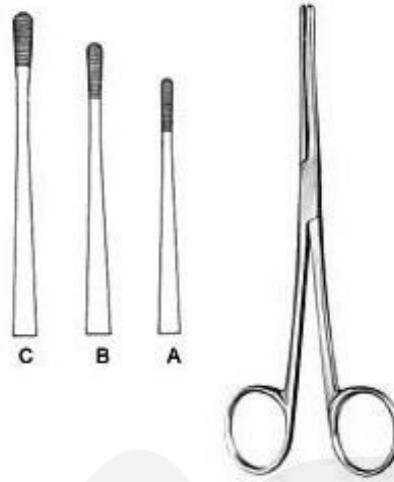

Lister
AC-5-802-13
Sinus Forceps
13 cm, 16 cm, 18 cm,



Martin
AC-5-803-17
Dressing Forceps
17.5 cm, 17 cm,

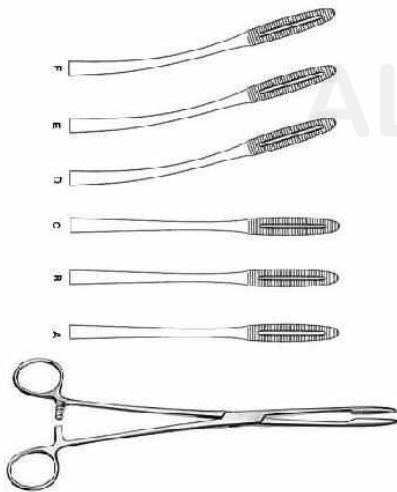

Gross-Maier
AC-5-804-20
Dressing Forceps
20.5 cm, 22 cm, 26.5 cm, 20 cm, 21.5 cm, 26 cm,



AC-5-805-40
Tunneling Forceps
39.5 cm,



Collin
AC-5-806-25
Dressing Forceps
25.5 cm,

Dressing & Sponge Forceps

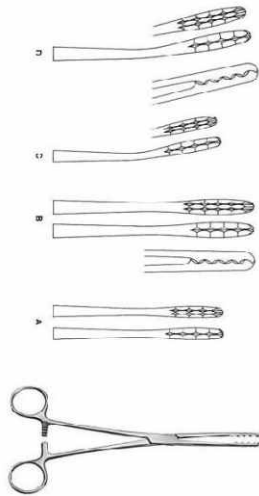

Ulrich
AC-5-801-22
Dressing Forceps
22.5 cm, 26.5 cm,

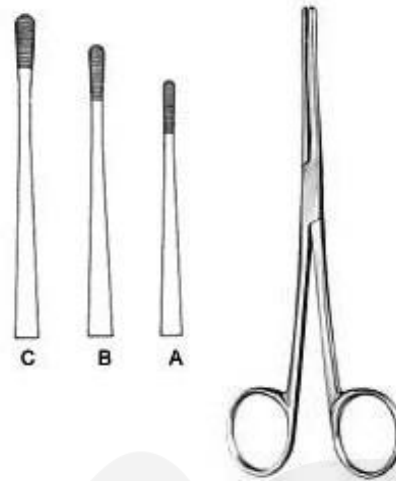

Lister
AC-5-802-13
Sinus Forceps
13 cm, 16 cm, 18 cm,



Martin
AC-5-803-17
Dressing Forceps
17.5 cm, 17 cm,

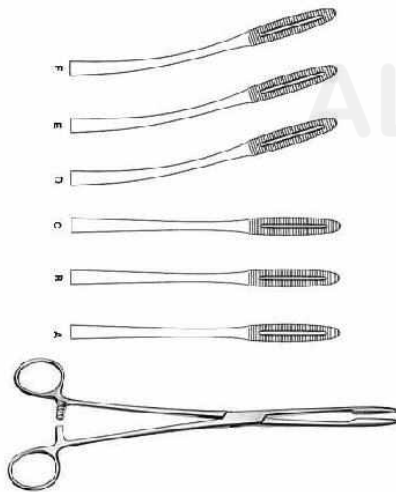

Gross-Maier
AC-5-804-20
Dressing Forceps
20.5 cm, 22 cm, 26.5 cm, 20 cm, 21.5 cm, 26 cm,



AC-5-805-40
Tunneling Forceps
39.5 cm,



Collin
AC-5-806-25
Dressing Forceps
25.5 cm,

Dressing & Sponge Forceps



Cheron
AC-5-807-25
Dressing Forceps
23.5 cm,



Bozemann
AC-5-808-26
Sponge Forceps
26 cm,

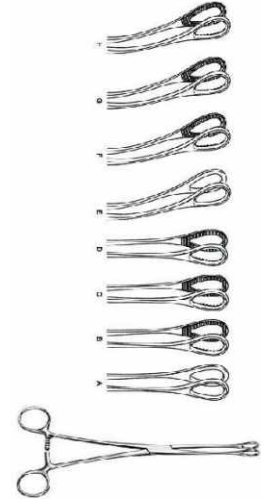

Foerster
AC-5-809-25
Sponge Forceps
25 cm, 18 cm, 20.5 cm, 24.5 cm, 17.5 cm, 20 cm, 24.5 cm,

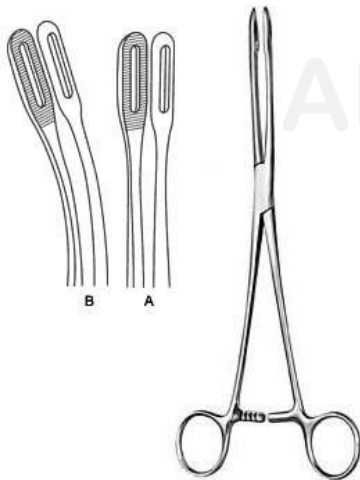

Foerster
AC-5-810-25
Sponge Forceps
25 cm, 24.5 cm,

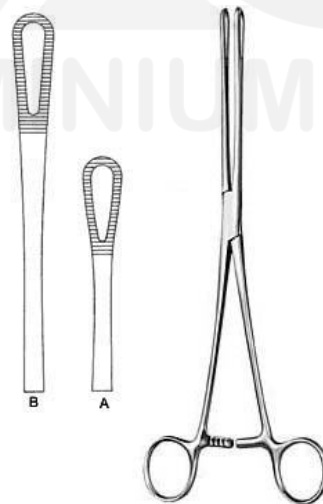

Rampley
AC-5-811-18
Sponge Forceps
18.5 cm, 24.5 cm,

Retractors



Vickers
AC-5-901-18
Skin Hooklet
18.5 cm,



Vickers
AC-5-902-01
Bone Hooklet
17 cm,



Vickers
AC-5-903-01
Tendon Hooklet
17 cm,



Vickers
AC-5-904-02
Hooklet
16 cm,

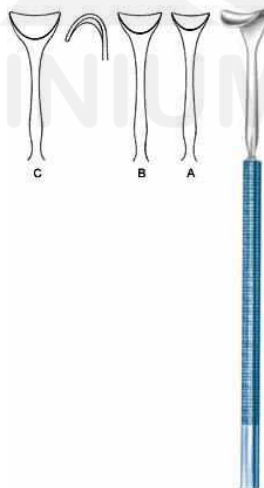

Vickers
AC-5-905-12
Saddle Hook
14 cm,



Graefe
AC-5-906-01
Micro Hooklet
15 cm,

Retractors

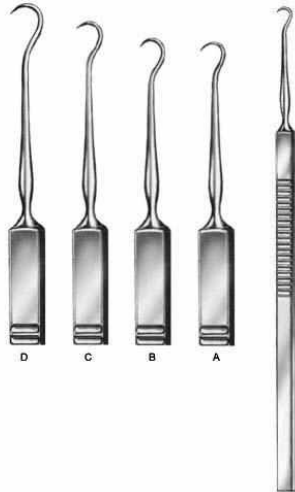

AC-5-907-01
Skin Hook
16 cm Fig. 1, 16 cm Fig. 2, 16 cm Fig. 3, 16 cm Fig. 4,



O Connor
AC-5-908-16
Skin Hook
16 cm,



Guthrie
AC-5-909-01
Skin Hook
15.5 cm,

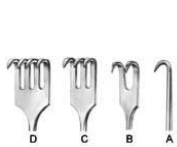

AC-5-910-01
Hooklet
16.5 cm,

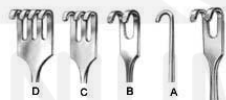

AC-5-911-01
Hooklet
16.5 cm,

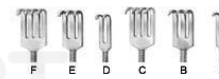

AC-5-912-02
Hooklet
16 cm,



Retractors



AC-5-913-04
Hooklet
16.5 cm,



AC-5-914-12
Vessel Hook
12 cm,

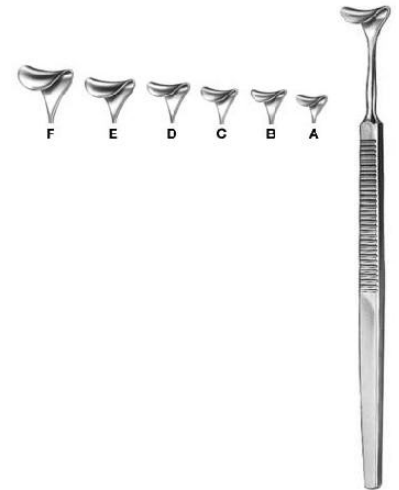

Desmarres
AC-5-915-08
Saddle Hook
16 cm 8 mm, 16 cm 10 mm, 16 cm 12 mm, 16
cm 14 mm, 16 cm 16 mm, 16 cm 18 mm,

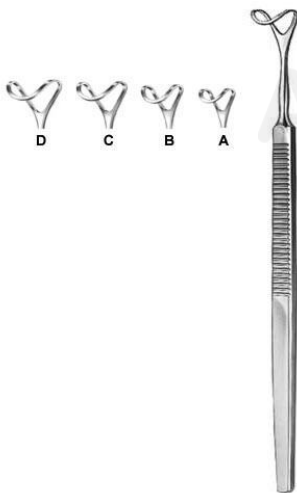

AC-5-916-12
Saddle Hook
16 cm 12 mm, 16 cm 14 mm, 16 cm 16 mm, 16
cm 18 mm,

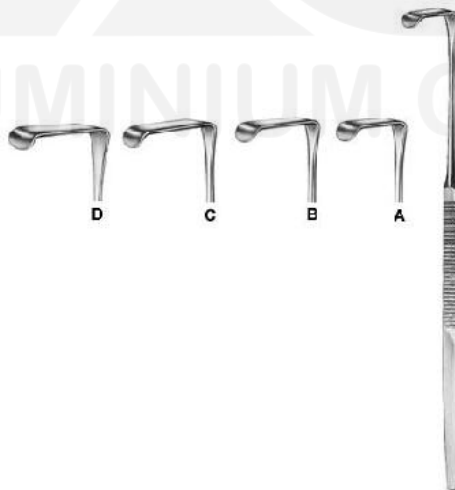

Langenbeck-Mini
AC-5-917-10
Hooklet
16 cm,



AC-5-918-16
Hooklet
16 cm 14 x 8,

Retractors



AC-5-919-01
Hooklet
16.5 cm,



AC-5-920-01
Hooklet
16.5 cm,



Meyerding
AC-5-921-01
Hooklet
17.5 cm Fig. 1, 17.5 cm Fig. 2, 17.5 cm Fig. 3, 17.5 cm Fig. 4, 17.5 cm Fig. 5, 17.5 cm Fig. 6,



Senn-Green
AC-5-922-01
Hooklet
15 cm Fig. 1, 15 cm Fig. 2,



Ragnell-Davis
AC-5-923-14
Hooklet
14 cm,

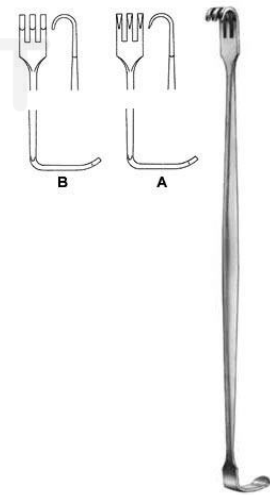

Senn-Miller
AC-5-924-16
Hooklet
16 cm,

Retractors



Cushing
AC-5-925-20
Retractor
20.5 cm,

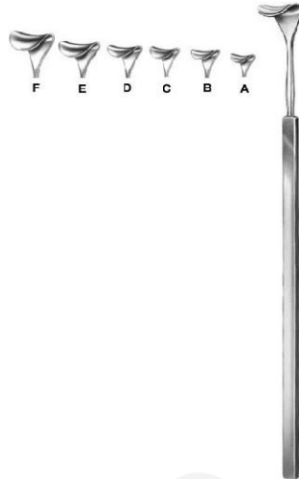

Cushing
AC-5-926-08
Saddle Hook
20.5 cm 8 mm wide, 20.5 cm 10 mm wide, 20.5 cm 12 mm wide, 20.5 cm 14 mm wide, 20.5 cm 16 mm wide, 20.5 cm 18 mm wide,

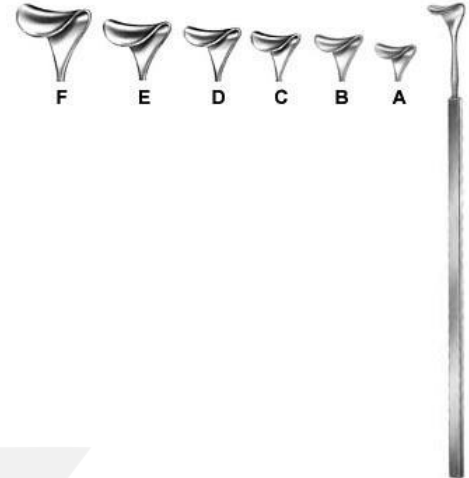

Cushing
AC-5-927-08
Saddle Hook 8 mm to 18 mm wide
24 cm,



Brom
AC-5-928-01
Vein Hook
19.5 cm,



Strandell-Stille
AC-5-929-01
Hooklet
19 cm Fig. 1, 19 cm Fig. 2,

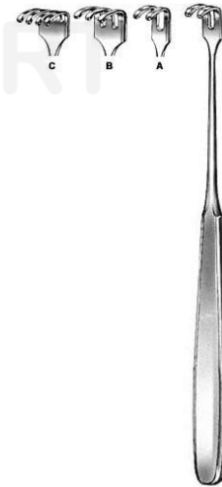

Klapp
AC-5-930-01
Retractor 12 x 6, 12 x 11, 15 x 11
17.5 cm,

Retractors



Cushing
AC-5-925-20
Retractor
20.5 cm,

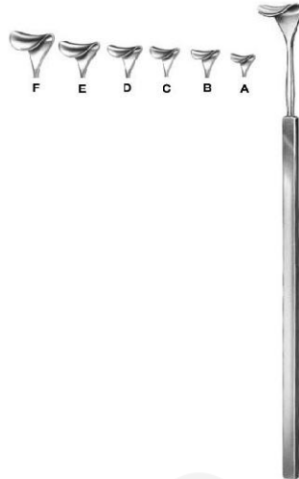

Cushing
AC-5-926-08
Saddle Hook
20.5 cm 8 mm wide, 20.5 cm 10 mm
wide, 20.5 cm 12 mm wide, 20.5 cm 14 mm
wide, 20.5 cm 16 mm wide, 20.5 cm 18 mm
wide,

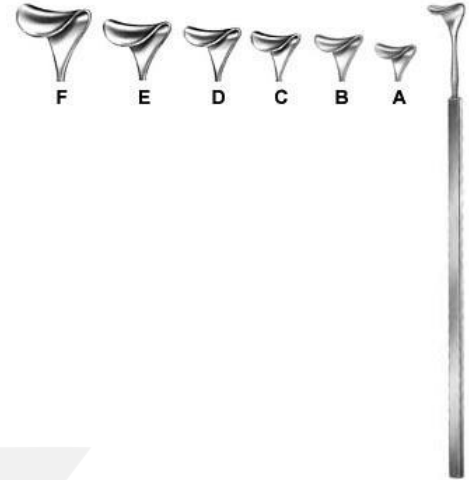

Cushing
AC-5-927-08
Saddle Hook 8 mm to 18 mm wide
24 cm,



Brom
AC-5-928-01
Vein Hook
19.5 cm,



Strandell-Stille
AC-5-929-01
Hooklet
19 cm Fig. 1, 19 cm Fig. 2,



Klapp
AC-5-930-01
Retractor 12 x 6, 12 x 11, 15 x 11
17.5 cm,

Retractors



AC-5-931-04
Hooklet
16.5 cm,

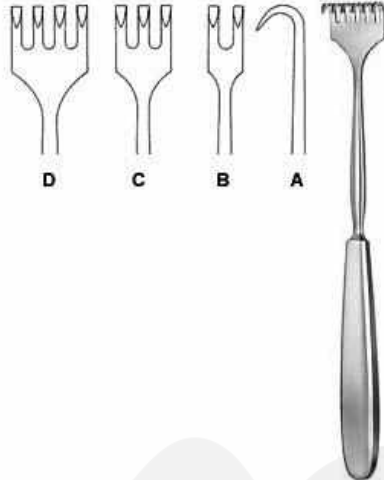

Volkmann
AC-5-932-01
Retractor
21.5 cm,

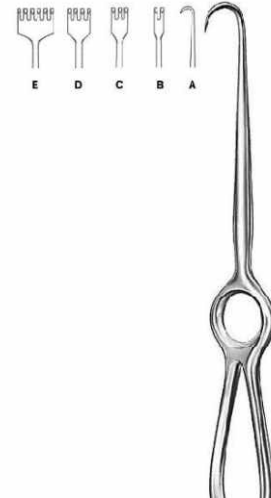

Volkmann
AC-5-933-01
Retractor
22 cm, 21.5 cm,



Kocher
AC-5-934-01
Retractor
22 cm,

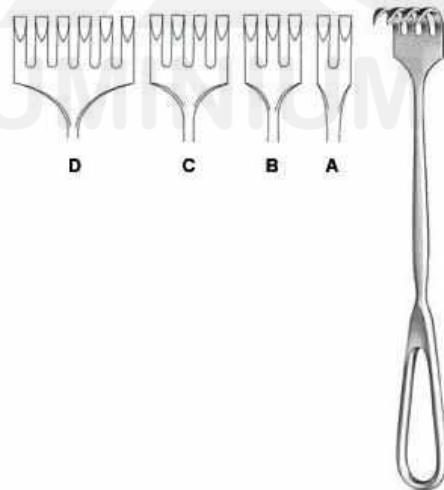

Martin
AC-5-935-02
Retractor
22.5 cm,

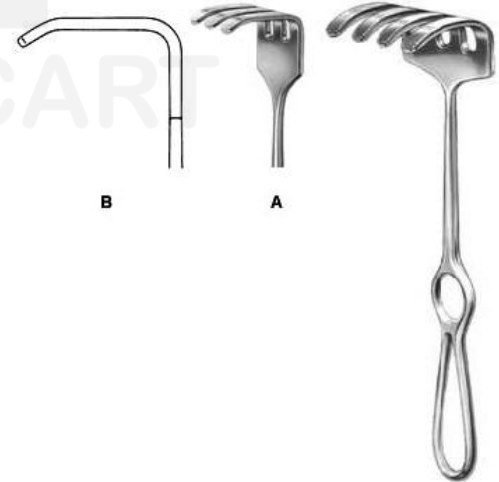

Ollier
AC-5-936-03
Retractor
23 cm 36 x 30, 23 cm 36 x 60,

Retractors

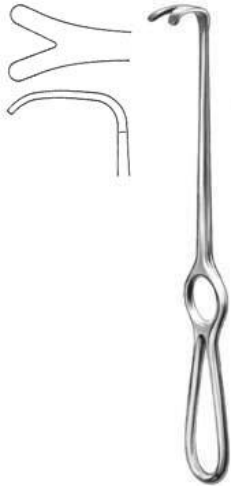

Wassmund
AC-5-937-02
Retractor
20.5 cm 33 x 21,

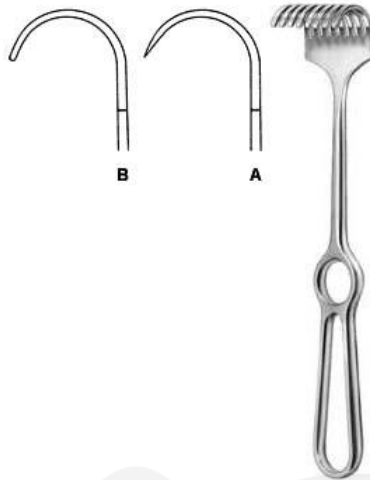

Korte
AC-5-938-08
Retractor
24.5 cm 40 x 30,

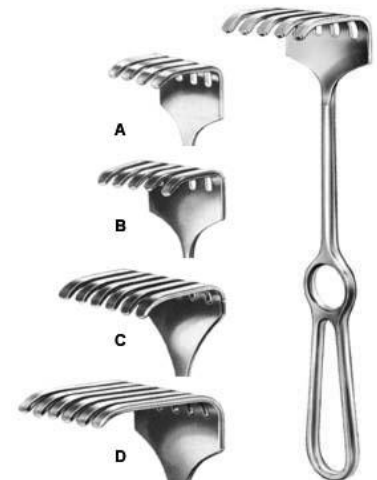

Israel
AC-5-939-04
Retractor
25.5 cm,

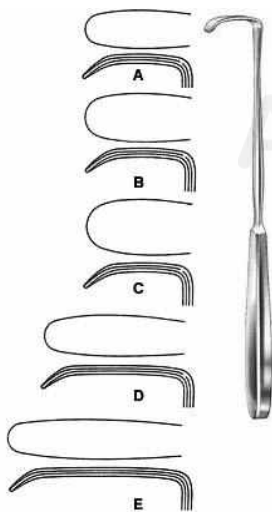

Langenbeck
AC-5-940-01
Retractor
22.5 cm 30 x 11 mm, 22.5 cm 30 x 14 mm, 22.5 cm 30 x 16 mm, 22.5 cm 40 x 11 mm, 22.5 cm 50 x 11 mm,



Langenbeck
AC-5-942-21
Retractor
21 cm 65 x 20 mm,



Langenbeck
AC-5-943-21
Retractor
22.5 cm 85 x 15 mm,

Retractors



Lahey
AC-5-944-19
Retractor
19.5 cm 36 x 19 mm,



Little
AC-5-945-20
Retractor
20 cm 13 x 15 mm,

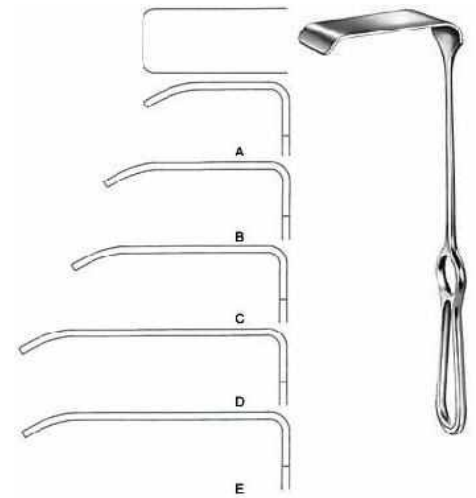

Kocher
AC-5-946-18
Retractor
23 cm 43 x 18 mm, 23 cm 53 x 20 mm, 23 cm
63 x 25 mm, 23 cm 77 x 30 mm, 23 cm 78 x
40 mm,

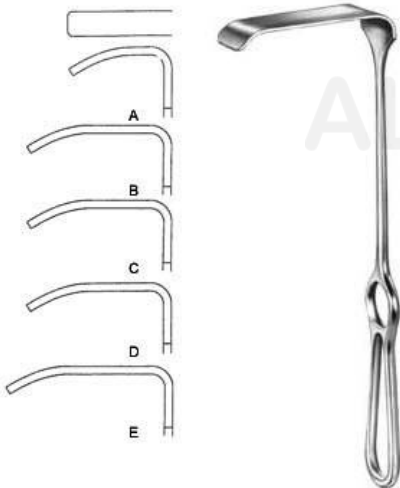

Kocher-Langenbeck
AC-5-947-01
Retractor
21.5 cm 25 x 6 mm, 21.5 cm 35 x 8 mm, 21.5
cm 35 x 11 mm, 21.5 cm 35 x 15 mm, 21.5 cm
40 x 11 mm, 21.5 cm 55 x 11 mm, 21.5 cm 70
x 14 mm, 21.5 cm 80 x 12 mm,

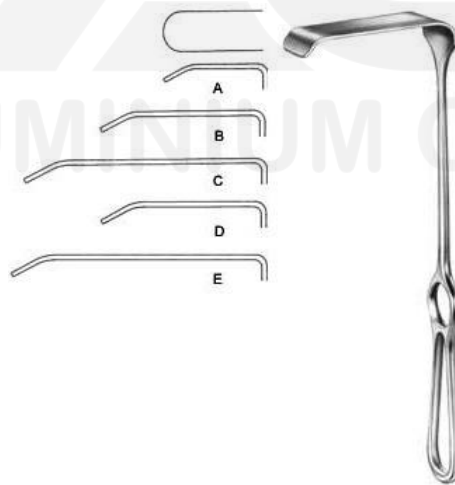

Kocher-Langenbeck
AC-5-948-01
Retractor
21.5 cm 25 x 10 mm, 21.5 cm 40 x 13
mm, 21.5 cm 60 x 13 mm, 21.5 cm 40 x 18
mm, 21.5 cm 60 x 18 mm, 21.5 cm 85 x 18
mm, 21.5 cm 60 x 25 mm, 21.5 cm 85 x 25
mm,

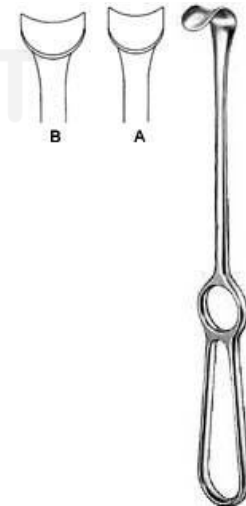

Kocher
AC-5-949-01
Retractor
21.5 cm 22 x 12 mm, 21.5 cm 24 x 14 mm,

Retractors

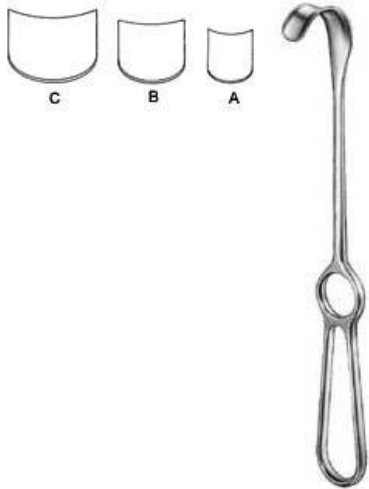

Kocher
AC-5-950-01
Retractor
22 cm 42 x 10 mm, 22 cm 42 x 15 mm, 22 cm 43 x 20 mm,

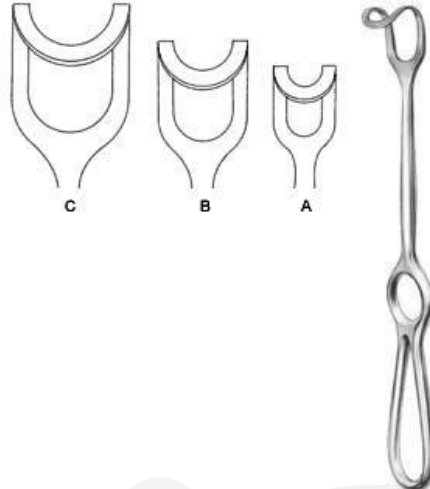

Middeldorpf
AC-5-951-01
Retractor
21.5 cm 18 x 17 mm, 23 cm 25 x 22 mm, 24.5 cm 30 x 31 mm,



Doyen-Stille
AC-5-952-01
Retractor
26 cm 97 x 29 mm, 26 cm 101 x 31 mm, 26 cm 127 x 52 mm,



Hosel
AC-5-953-01
Retractor
26 cm 63 x 21 mm, 26 cm 83 x 30 mm, 26 cm 103 x 30 mm, 26 cm 120 x 30 mm, 26 cm 140 x 30 mm, 26 cm 140 x 40 mm,

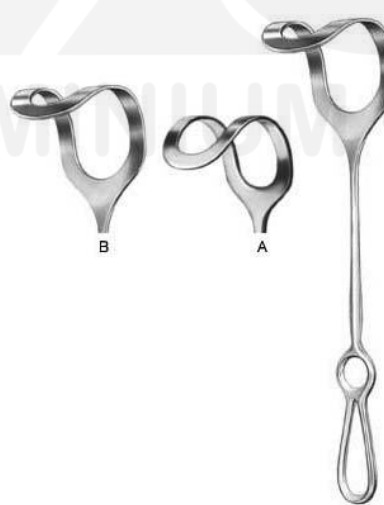

Middeldorpf
AC-5-954-01
Retractor
27 cm 48 x 45 mm, 27 cm 52 x 50 mm, 27 cm 60 x 70 mm,

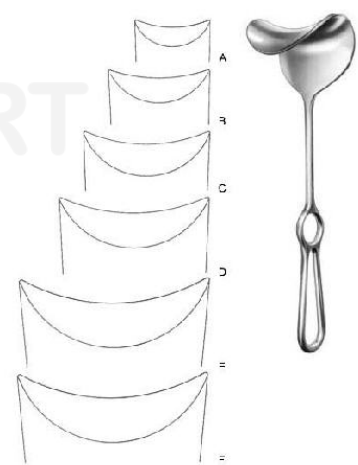

Fritsch
AC-5-955-00
Retractor
23.5 cm 37 x 31 mm, 24 cm 38 x 40 mm, 25 cm 43 x 51 mm, 25 cm 49 x 61 mm, 25.5 cm 48 x 75 mm, 25.5 cm 65 x 85 mm,

Retractors



AC-5-956-22
Retractor
24 cm 48 x 88 mm,



Kocher
AC-5-957-22
Retractor
24 cm 73 x 25 mm,



Kocher
AC-5-958-01
Retractor
25 cm 80 x 45 mm, 25 cm 80 x 55 mm, 25 cm
80 x 65 mm,



AC-5-959-01
Retractor
26 cm 110 x 27 mm,

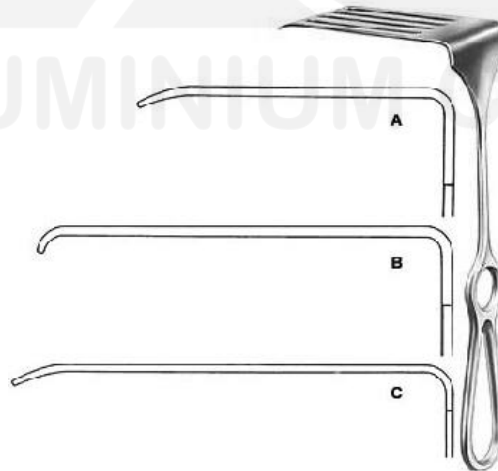

Coryllos
AC-5-960-01
Retractor
24 cm 85 x 22 mm, 24 cm 108 x 43 mm, 24 cm
119 x 65 mm,



Davidson
AC-5-961-01
Retractor
19 cm 80 x 54 mm, 18.5 cm 80 x 95 mm,

Retractors

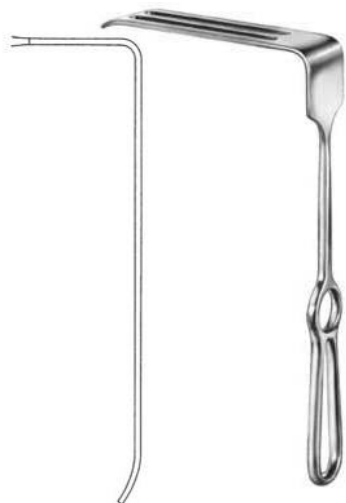

Sauerbruch
AC-5-962-25
Retractor
25.5 cm 127 x 38 mm,

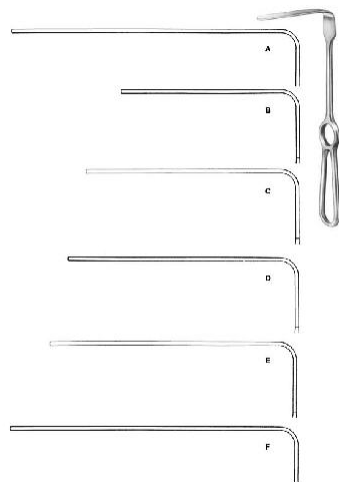

Brunner
AC-5-963-08
Retractor
25.5 cm 84 x 20 mm, 25.5 cm 104 x 25 mm, 25.5 cm 124 x 30 mm, 25.5 cm 130 x 30 mm, 25.5 cm 144 x 30 mm, 25.5 cm 160 x 30 mm, 25.5 cm 164 x 30 mm,

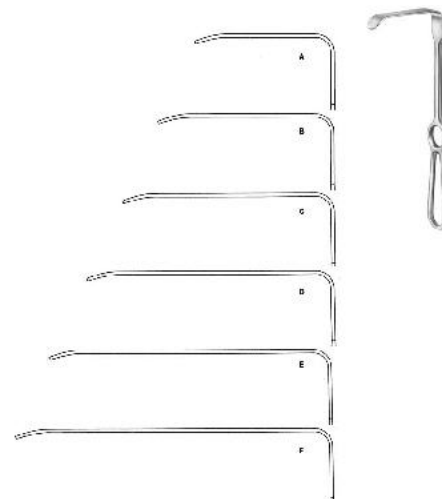

Brunner
AC-5-964-08
Retractor
25.5 cm 82 x 20 mm, 25.5 cm 102 x 20 mm, 25.5 cm 122 x 25 mm, 25.5 cm 140 x 25 mm, 25.5 cm 162 x 30 mm, 25.5 cm 182 x 30 mm,

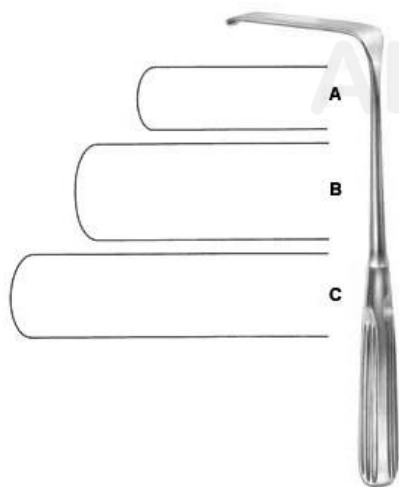

Sauerbruch
AC-5-965-01
Retractor
22.5 cm 50 x 15mm, 22.5 cm 63 x 23mm, 22.5 cm 80 x 20mm,



Deaver
AC-5-966-01
Retractor
18 cm 19mm,

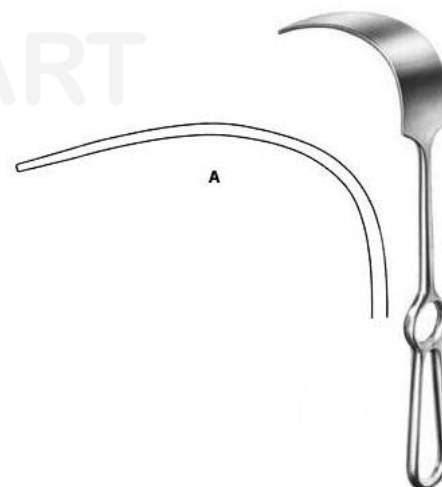

Mikulicz
AC-5-968-01
Retractor
25 cm 90 x 35mm, 25 cm 125 x 50mm, 25 cm 160 x 50mm,

Retractors



Mikulicz
AC-5-969-26
Retractor
26 cm 90 x 55mm,

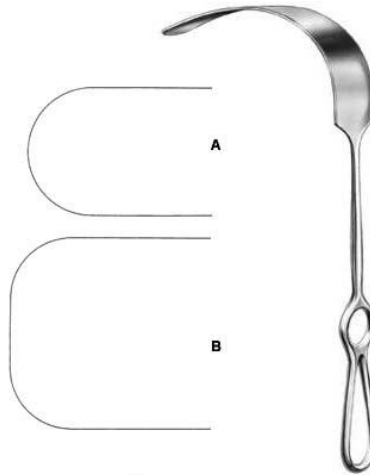

Kelly
AC-5-970-01
Retractor
27.5 cm 205 x 38mm, 27.5 cm 205 x 57mm,



Farabeuf
AC-5-971-00
Retractor
15 cm Fig. 1 = 23 x 16, 15 cm Fig. 1 = 26 x 16, 15 cm Fig. 2 = 27 x 16, 15 cm Fig. 2 = 30 x 16,

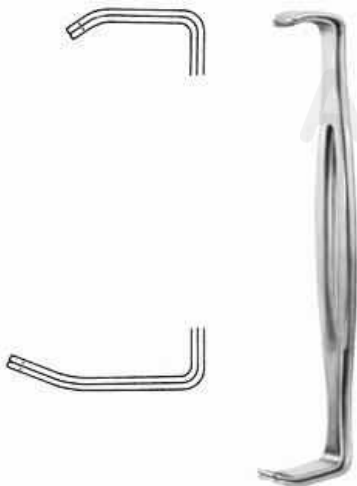

Parker-Langenbeck
AC-5-972-00
Retractor
21.5 cm Fig. 1 = 21x15mm, 21.5 cm Fig. 1 = 40x15mm, 21.5 cm Fig. 2 = 25x15mm, 21.5 cm Fig. 2 = 45x15mm,



Alm
AC-5-973-07
Wound Spreaders, self-retaining
7 cm,



Alm
AC-5-974-07
Wound Spreaders, self-retaining
7 cm,

Retractors



Gosset
AC-5-975-22
Abdominal Retractor
18.5 cm,



Balfour-Baby
AC-5-976-00
Abdominal Retractor spreading 90mm, 1
central blade 24 x 20mm
12.5 cm,



Balfour
AC-5-977-00
Abdominal Retractor spreading 180mm,
lateral blades 70 x 35mm, 1 central blade
20 cm,



Deaver
AC-5-967-04
Retractor
31.5 cm 25mm, 31.5 cm 38mm, 31.5 cm
50mm, 31.5 cm 100mm,

Probes



AC-5-1001-11
Probe

11.5 cm, 13 cm, 14.5 cm, 16 cm, 18 cm, 20 cm, 25 cm, 30 cm,



AC-5-1002-11
Probe

11.5 cm, 13 cm, 14.5 cm, 16 cm, 18 cm, 20 cm, 25 cm, 30 cm,

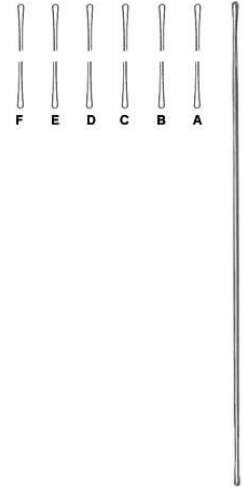

AC-5-1003-13
Probe

13 cm, 14.5 cm, 16 cm, 18 cm, 20 cm, 25 cm,



AC-5-1004-13
Probe with eye
13 cm, 14.5 cm, 16 cm,

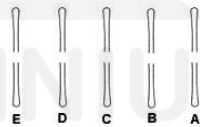

AC-5-1006-13
Myrtle Leaf Probe
13 cm, 14.5 cm, 16 cm, 18 cm, 20 cm,



AC-5-1007-13
Grooved Director
13 cm, 14 cm, 16 cm,

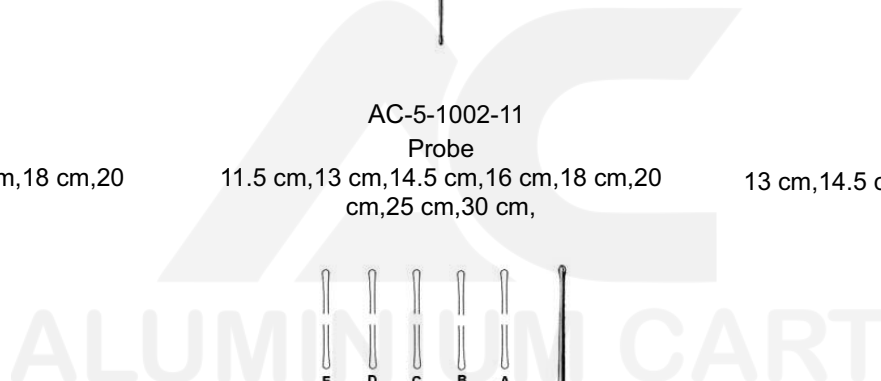

Probes



AC-5-1008-13
Grooved Director
13 cm, 14.5 cm, 16 cm,



Doyen
AC-5-1009-14
Grooved Director
14.5 cm,



Nelaton
AC-5-1010-16
Grooved Director
16 cm,

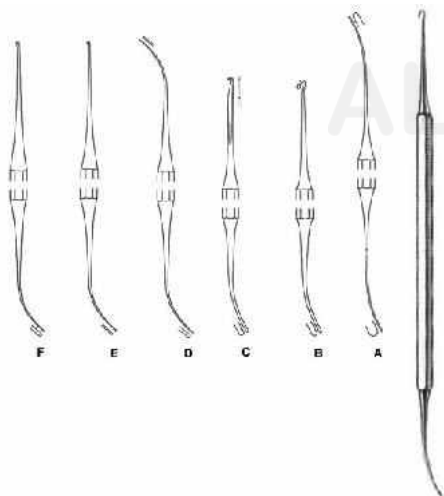

Varady
AC-5-1011-01
Phlebodissector
18 cm, 17.5 cm,

Plaster

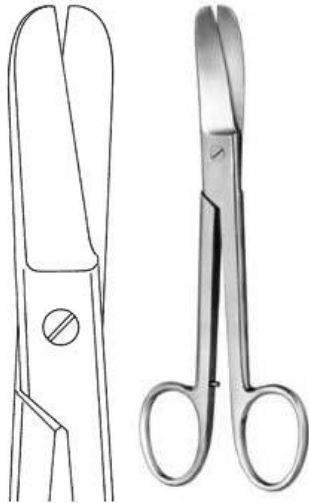

Lorenz
AC-6-101-23
Bandage Scissors heavy pattern
23 cm,



Lister
AC-6-102-14
Bandage Scissors
14.5 cm, 18.5 cm, 20 cm,

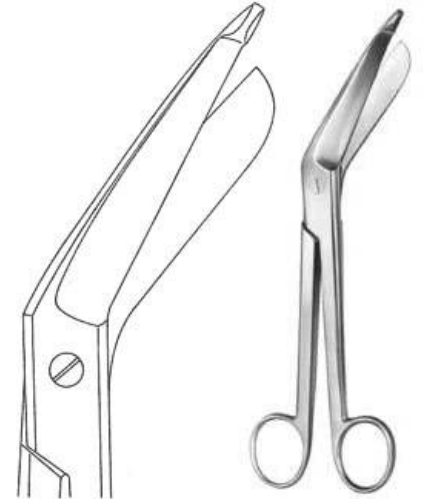

Bergmann
AC-6-103-23
Plaster Shears
23.5 cm,



Esmarch
AC-6-104-20
Plaster Shears heavy pattern, short blades
20 cm,



AC-6-105-15
Bandage Scissors black plastic ring with
autodavable
16 cm, 19 cm,



AC-6-106-18
Bandage Scissors black plastic rings
19 cm, 16 cm,

Probes

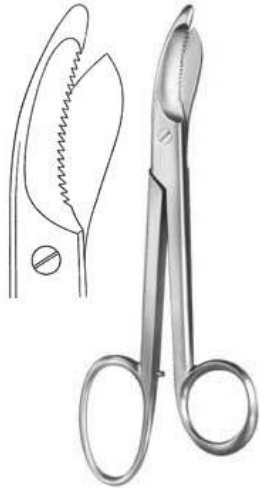

Bruns
AC-6-107-24
Plaster Scissors
24 cm,

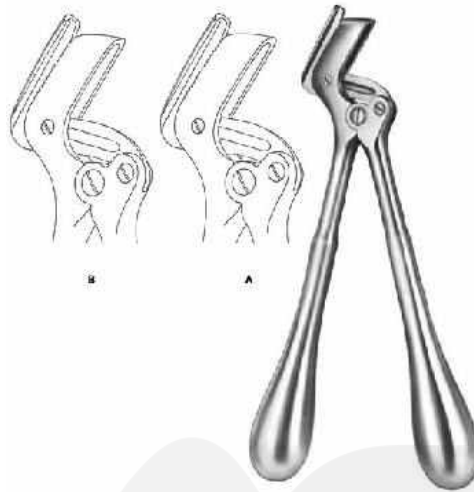

Stille-Martin
AC-6-108-23
Plaster Shears
23 cm, 27 cm, 38 cm,

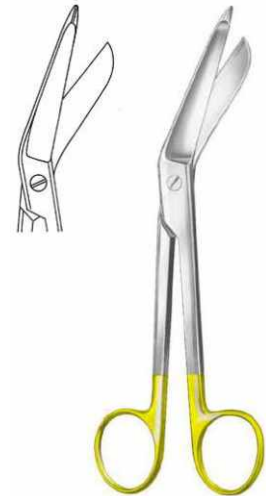

Lister
AC-6-109-18
Bandage Scissors
18 cm,

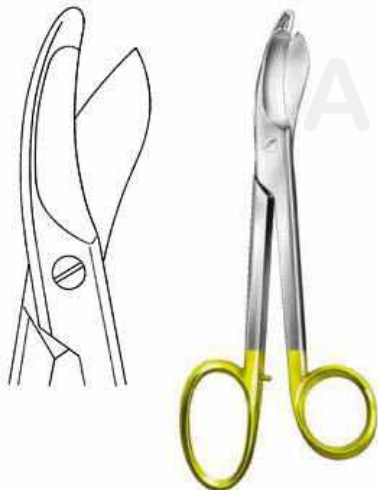

Bruns
AC-6-110-24
Plaster Scissors
24 cm,



Hopkins
AC-6-111-20
Plaster Knife with wooden handle
20 cm,



Reiner
AC-6-112-18
Plaster Knife
18 cm,

Probes



Reiner
AC-6-113-18
Plaster Knife
18 cm,



Martin
AC-6-114-21
Plaster Knife with wooden handle
21 cm,



Engel
AC-6-115-14
Plaster Saw
15.5 cm,

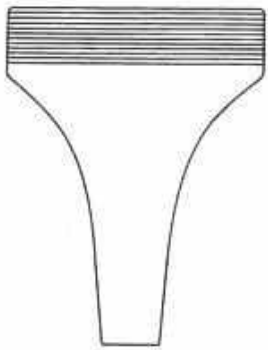

Hennig
AC-6-116-28
Plaster Spreader
28 cm,



Wolff
AC-6-117-18
Plaster Breaker
18 cm, 26.5 cm,

Neurosurgery



Gigli
AC-8-101-01
Wire Saw Handle



De Martel
AC-8-102-33
Wire Saw Guide
33 cm,



Crutchfield
AC-8-103-01
Skull Traction Tong small pattern



AC-8-104-01
Skull Traction Tong large pattern
22.5 cm,



Dahlgren
AC-8-105-20
Cranial Rongeur
20 cm,



Olivecrona-Toennis
AC-8-106-14
Clip Applying Forceps

Neurosurgery



McKenzie
AC-8-107-19
Clip Applying Forceps
18.5 cm,



Olivecrona
AC-8-108-18
Dura Dissector
18 cm,



Olivecrona
AC-8-109-19
Dura Dissector
20 cm,



Milligan
AC-8-110-21
Dura Dissector
21.5 cm,



Davis
AC-8-111-21
Dura Dissector sharp
21.5 cm,



AC-8-112-22
Dura Dissector
22 cm,

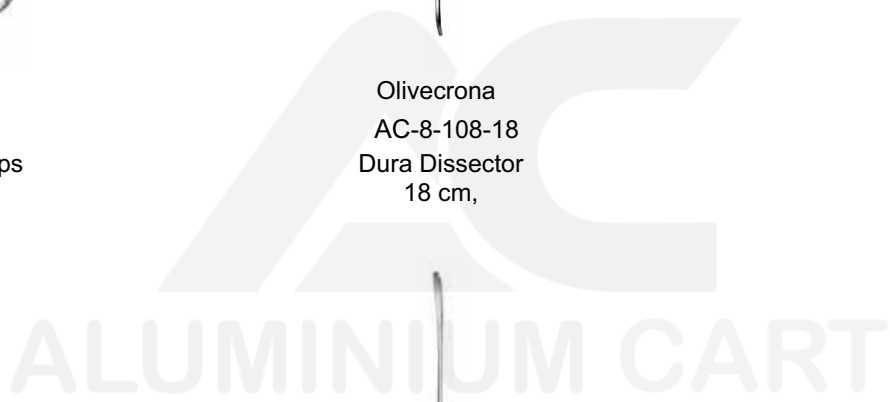

Neurosurgery



Davis
AC-8-113-24
Dura Dissector
24.5 cm,



Love
AC-8-114-19
Nerve Root Retractor
21.5 cm, 18 cm, 11 cm,



Olivecrona
AC-8-115-18
Brain Spatula
18 cm,



Scoville
AC-8-116-23
Nerve Root Retractor 8mm
23.5 cm,



Holsher
AC-8-117-24
Nerve Root Retractor 8mm
23.5 cm,



Scoville
AC-8-118-19
Nerve Root Retractor 7mm
16.5 cm,

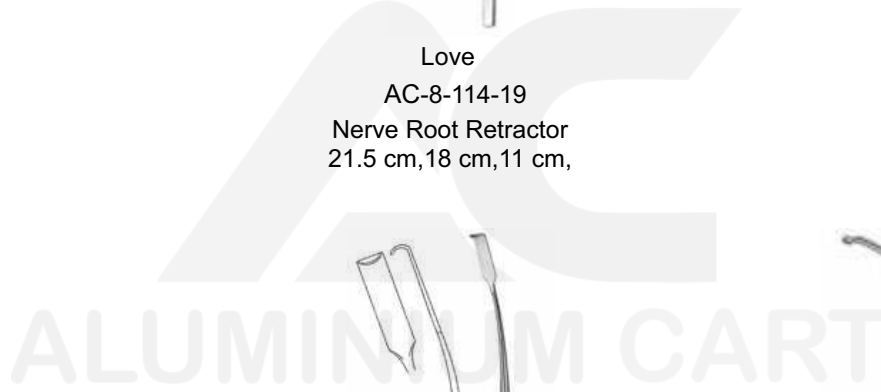

Neurosurgery



Groningen
AC-8-119-26
Nerve Hook
26.5 cm,



Groningen
AC-8-120-26
Nerve Hook
26.5 cm,



Cushing
AC-8-121-19
Nerve Hook blunt
19 cm, 28 cm,

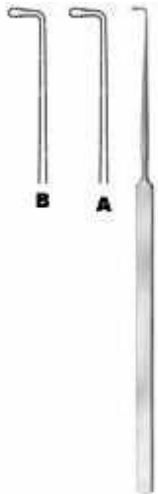

Cushing
AC-8-122-19
Nerve Hook
19.5 cm, 28 cm,



Smithwick
AC-8-123-17
Nerve Hook
17 cm, 21 cm,



Halle
AC-8-125-20
Dura Knife
20 cm,



Neurosurgery



Adson
AC-8-126-20
Dura Hook
20 cm,



Graham
AC-8-127-16
Dura Hook blunt
16.5 cm,



Sachs
AC-8-128-18
Dura Hook sharp
18 cm,



Toennis
AC-8-129-15
Dura Hook sharp
14.5 cm,



Frazier
AC-8-130-13
Dura Hook sharp
13 cm, 18 cm,



Krayenbuhl
AC-8-131-01
Nerve and Vessel Hooklet
18.5 cm Fig. 1, 18.5 cm Fig. 2,

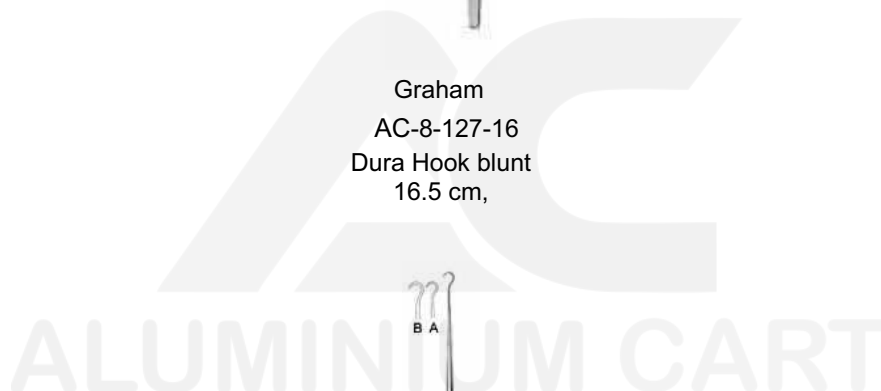

Neurosurgery



Cloward
AC-8-132-16
Lamina Spreader
16 cm,

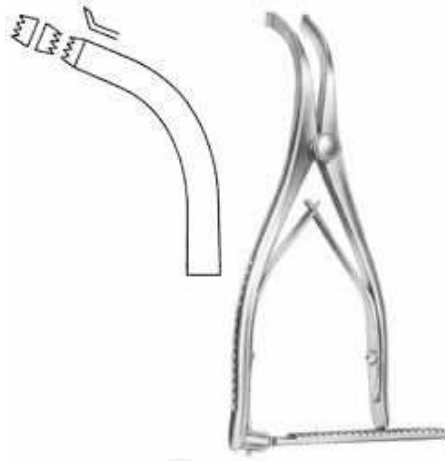

Inge
AC-8-133-17
Lamina Spreader
16 cm,

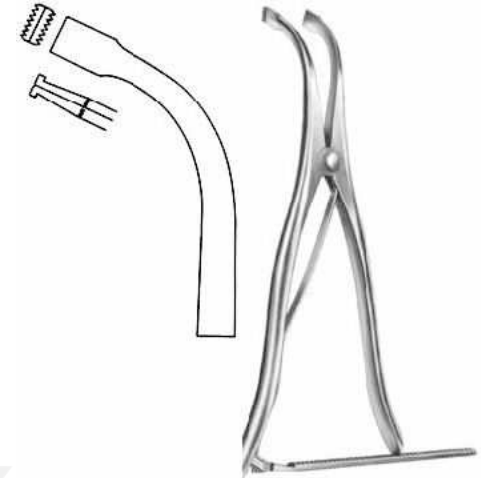

Inge
AC-8-134-27
Lamina Spreader
25.5 cm,

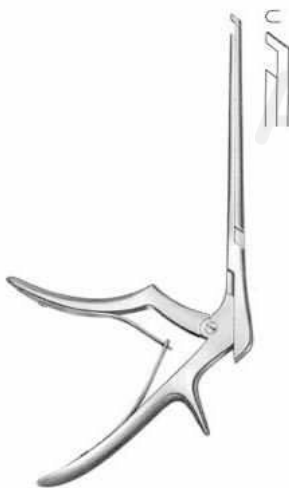

Ferris-Smith Kerrison
AC-8-135-03
Laminaectomy Punch 3mm downwards cutting
40 degree shaft length 180 mm

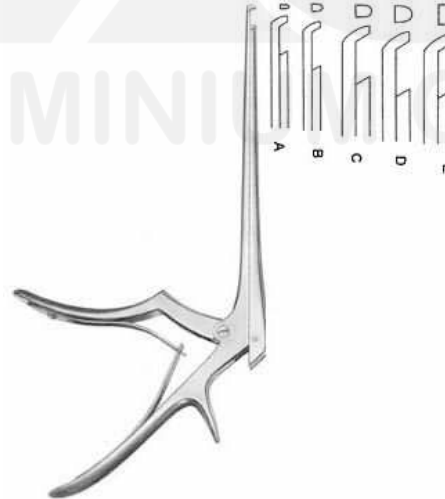

Ferris-Smith Kerrison
AC-8-138-01
Laminaectomy Punch upwards cutting shaft
length 180 mm
1 mm, 2 mm, 3 mm, 4 mm, 5 mm, 6 mm,

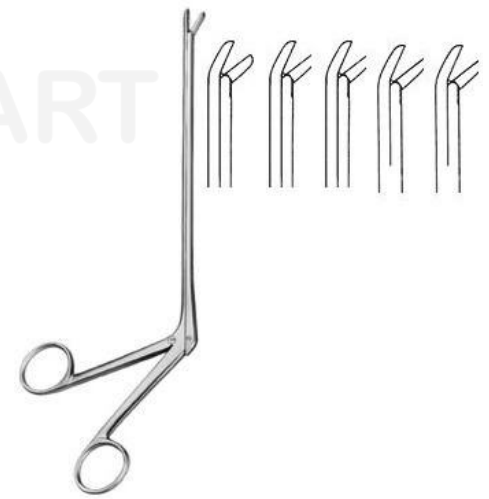

Cushing
AC-8-139-01
Laminaectomy Rongeur jaw 2 x 10 to 4 x 10
mm straight shaft length 180 mm

Neurosurgery

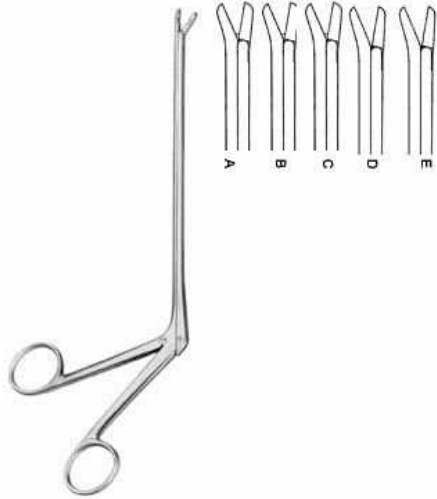

Cushing
AC-8-140-01
Laminectomy Rongeur jaw 2 x 10 to 4 x 10 mm upwards 45 degree shaft length 120 mm

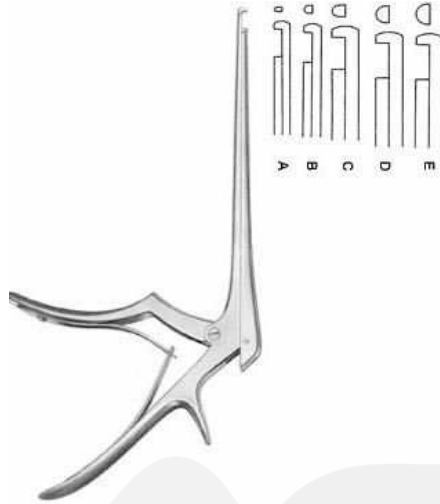

Ferris-Smith Kerrison
AC-8-137-01
Laminectomy Punch
1 mm, 2 mm, 3 mm, 4 mm, 5 mm, 6 mm,

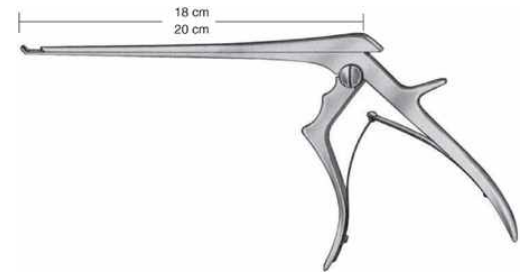

FERRIS-SMITH-KERRISON
AC-9-137-01
with thin footplate

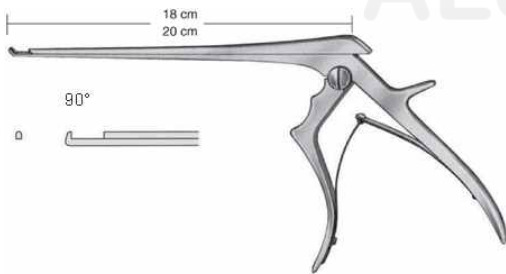

FERRIS-SMITH-KERRISON
AC-9-137-02
With thin footplate
18 cm , 20 cm , 1mm , 2 mm , 3 mm , 4 mm , 5 mm,

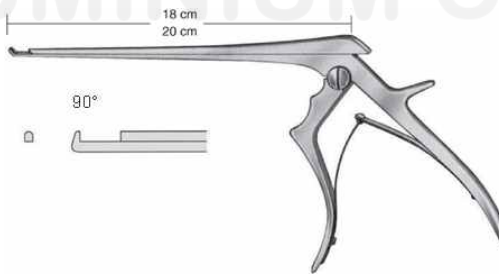

FERRIS-SMITH-KERRISON
AC-9-137-03
With thin footplate
18 cm , 20 cm , 1mm , 2 mm , 3 mm , 4 mm , 5 mm,

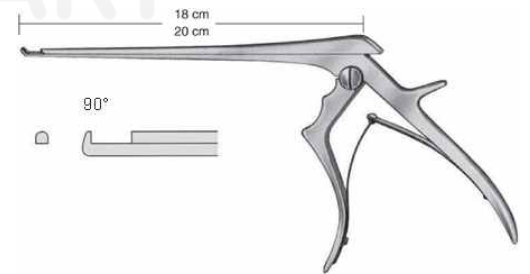

FERRIS-SMITH-KERRISON
AC-9-137-04
With thin footplate
18 cm , 20 cm , 1mm , 2 mm , 3 mm , 4 mm , 5 mm,

Neurosurgery

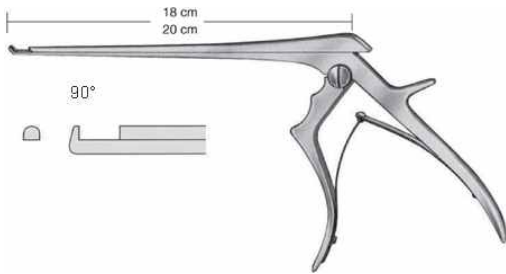

FERRIS-SMITH-KERRISON

AC-9-137-05

With thin footplate

18 cm , 20 cm , 1 mm ,2 mm,3 mm ,4 mm ,5 mm,

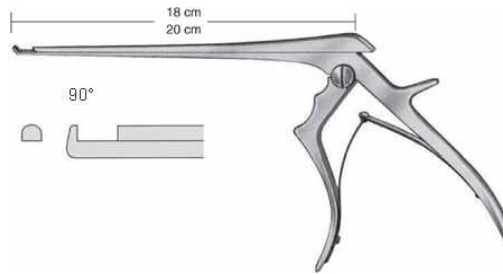

FERRIS-SMITH-KERRISON

AC-9-137-06

With thin footplate

18 cm , 20 cm , 1 mm ,2 mm,3 mm ,4 mm ,5 mm,

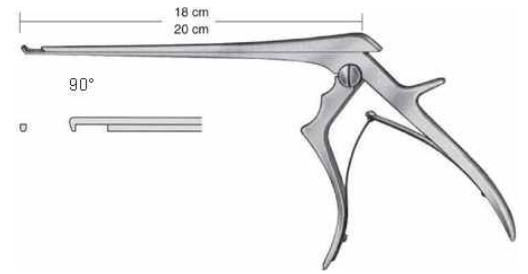

FERRIS-SMITH-KERRISON

AC-9-137-07

with thin footplate

18 cm , 20 cm , 1 mm,2 mm,3 mm,4 mm,5 mm,

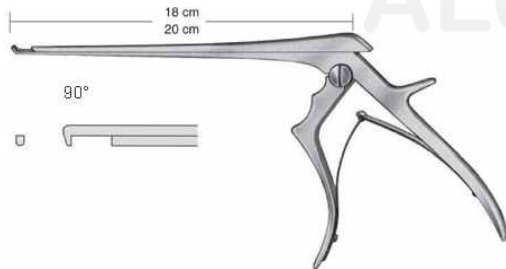

FERRIS-SMITH-KERRISON

AC-9-137-08

with thin footplate

18 cm , 20 cm , 1 mm,2 mm,3 mm,4 mm,5 mm,

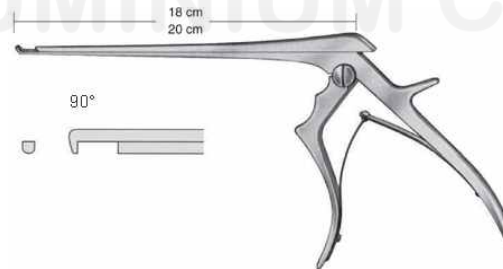

FERRIS-SMITH-KERRISON

AC-9-137-09

with thin footplate

18 cm , 20 cm , 1 mm,2 mm,3 mm,4 mm,5 mm,

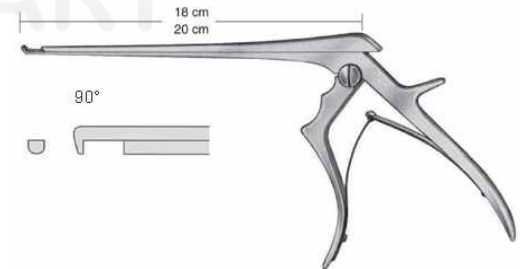

FERRIS-SMITH-KERRISON

AC-9-137-10

with thin footplate

18 cm , 20 cm , 1 mm,2 mm,3 mm,4 mm,5 mm,

Neurosurgery

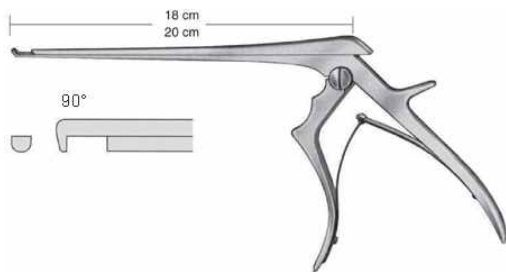

FERRIS-SMITH-KERRISON
AC-9-137-11
with thin footplate
18 cm , 20 cm , 1 mm,2 mm,3 mm,4 mm,5 mm,

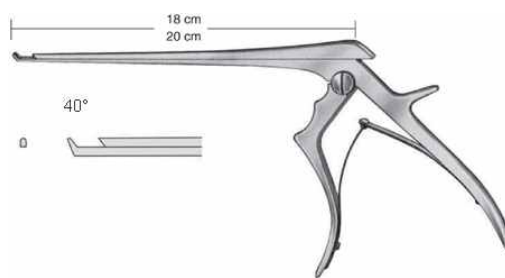

FERRIS-SMITH-KERRISON
AC-9-137-12
with thin footplate
1 mm,2 mm,3 mm,4 mm,5 mm,

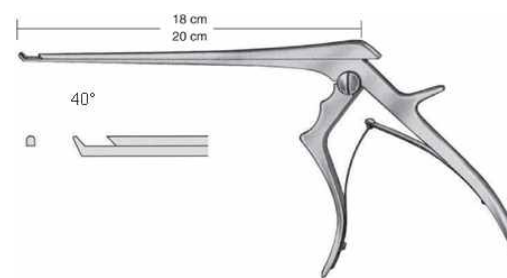

FERRIS-SMITH-KERRISON
AC-9-137-13
with thin footplate
1 mm,2 mm,3 mm,4 mm,5 mm,

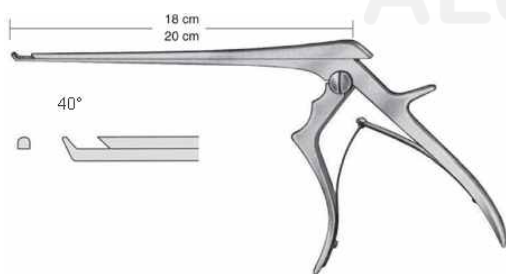

FERRIS-SMITH-KERRISON
AC-9-137-14
with thin footplate
1 mm,2 mm,3 mm,4 mm,5 mm,

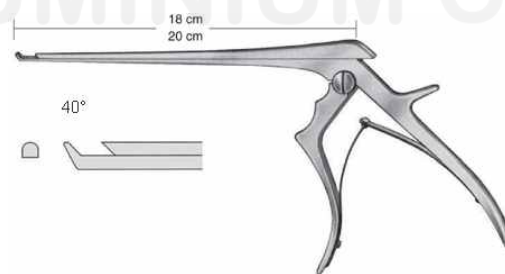

FERRIS-SMITH-KERRISON
AC-9-137-15
with thin footplate
1 mm,2 mm,3 mm,4 mm,5 mm,

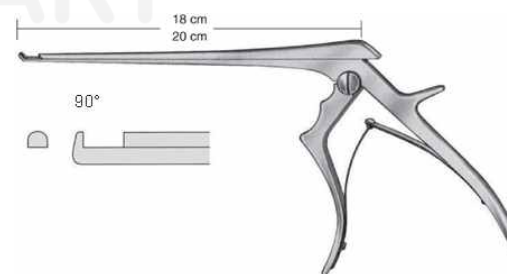

FERRIS-SMITH-KERRISON
AC-9-137-16
with thin footplate
1 mm,2 mm,3 mm,4 mm,5 mm,

Neurosurgery

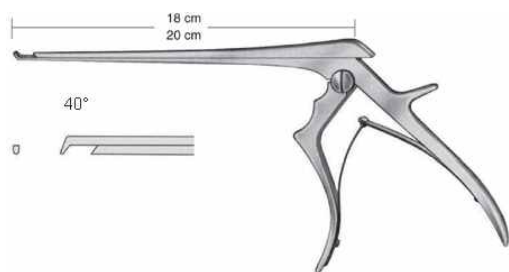

FERRIS-SMITH-KERRISON
AC-9-137-17
with thin footplate
1 mm,2 mm,3 mm,4 mm,5 mm,

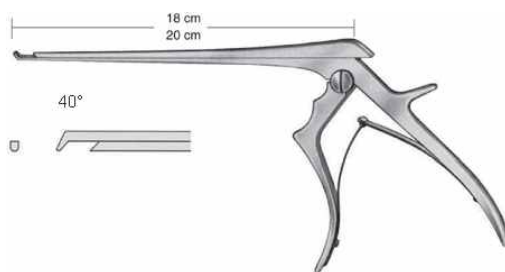

FERRIS-SMITH-KERRISON
AC-9-137-18
with thin footplate
1 mm,2 mm,3 mm,4 mm,5 mm,

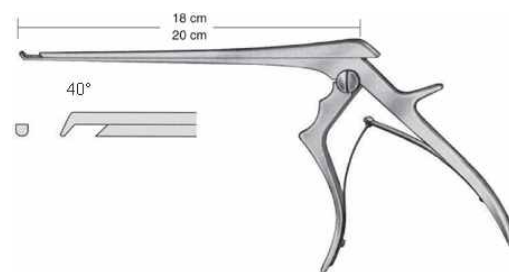

FERRIS-SMITH-KERRISON
AC-9-137-19
with thin footplate
1 mm,2 mm,3 mm,4 mm,5 mm,

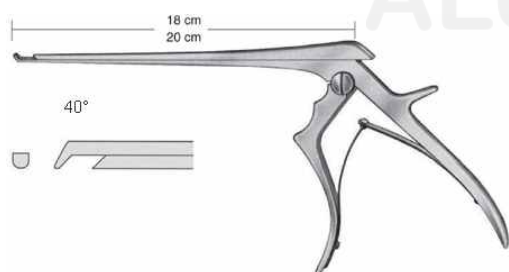

FERRIS-SMITH-KERRISON
AC-9-137-20
with thin footplate
1 mm,2 mm,3 mm,4 mm,5 mm,

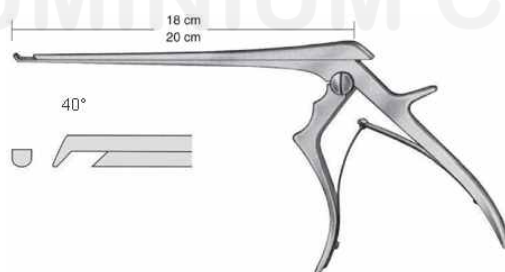

FERRIS-SMITH-KERRISON
AC-9-137-21
with thin footplate
1 mm,2 mm,3 mm,4 mm,5 mm,



AC-9-137-22
18 cm,20 cm ,

Neurosurgery



AC-9-137-23

18 cm , 20 cm , 1mm,2 mm,3 mm,4 mm,5 mm,6 mm,



AC-9-137-24

18 cm , 20 cm , 1mm,2 mm,3 mm,4 mm,5 mm,6 mm,



AC-9-137-25

18 cm , 20 cm , 1mm,2 mm,3 mm,4 mm,5 mm,6 mm,



AC-9-137-26

18 cm , 20 cm , 1mm,2 mm,3 mm,4 mm,5 mm,6 mm,



AC-9-137-27

18 cm , 20 cm , 1mm,2 mm,3 mm,4 mm,5 mm,6 mm,



AC-9-137-28

18 cm , 20 cm , 1mm,2 mm,3 mm,4 mm,5 mm,6 mm,

Neurosurgery

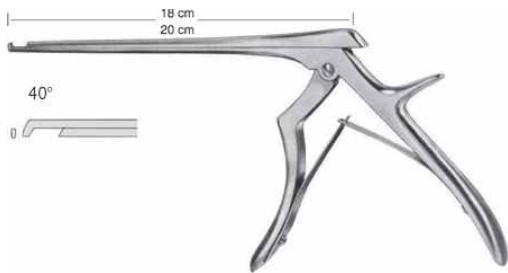

AC-9-137-29

18 cm , 20 cm , 1mm,2 mm,3 mm,4 mm,5 mm,6 mm,

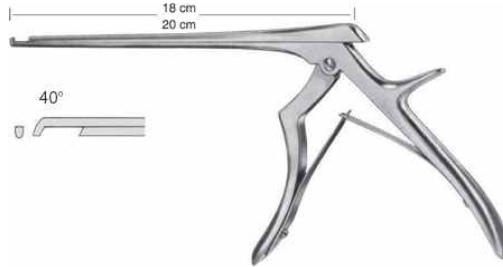

AC-9-137-30

18 cm , 20 cm , 1mm,2 mm,3 mm,4 mm,5 mm,6 mm,

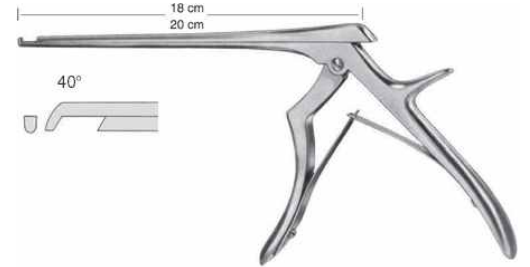

AC-9-137-31

18 cm , 20 cm , 1mm,2 mm,3 mm,4 mm,5 mm,6 mm,

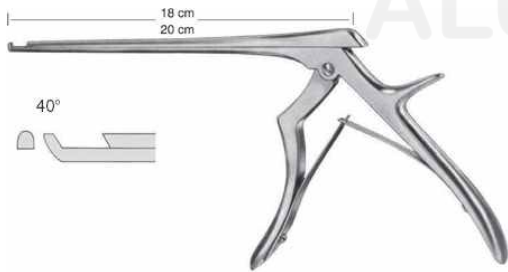

AC-9-137-32

18 cm , 20 cm , 1mm,2 mm,3 mm,4 mm,5 mm,6 mm,

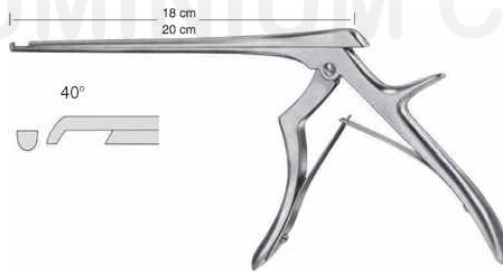

AC-9-137-33

18 cm , 20 cm , 1mm,2 mm,3 mm,4 mm,5 mm,6 mm,

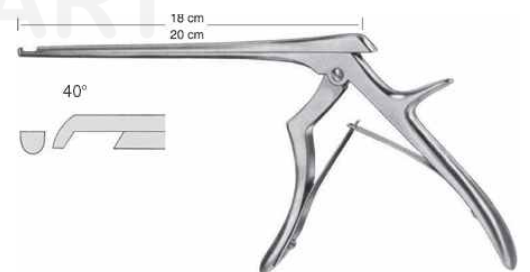

AC-9-137-34

18 cm , 20 cm , 1mm,2 mm,3 mm,4 mm,5 mm,6 mm,

Neurosurgery



detachable
AC-9-137-35
detachable

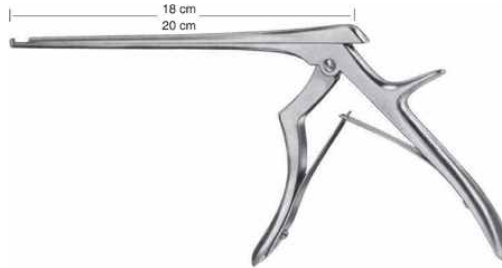

FERRIS-SMITH-KERRISON
AC-9-137-36
FERRIS-SMITH-KERRISON

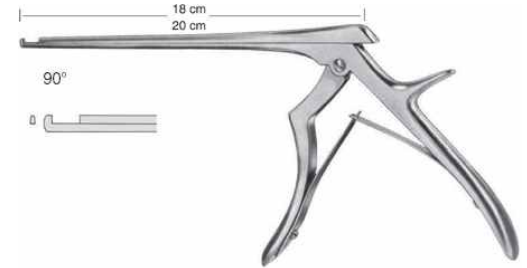

FERRIS-SMITH-KERRISON
AC-9-137-37
FERRIS-SMITH-KERRISON
18 cm , 20 cm ,
1mm,2mm,3mm,4mm,5mm,6mm,

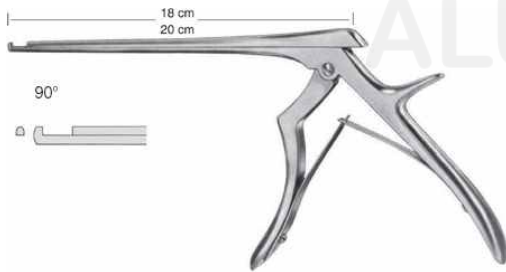

FERRIS-SMITH-KERRISON
AC-9-137-38

FERRIS-SMITH-KERRISON
18 cm , 20 cm , 1mm,18 cm , 20 cm ,
2mm,18 cm , 20 cm , 3mm,18 cm , 20 cm ,
4mm,18 cm , 20 cm , 5mm,18 cm , 20 cm ,
6mm,

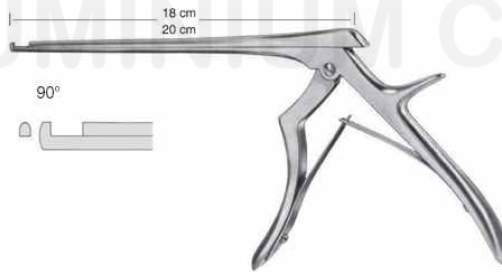

FERRIS-SMITH-KERRISON
AC-9-137-39

FERRIS-SMITH-KERRISON
18 cm , 20 cm , 1mm,18 cm , 20 cm ,
2mm,18 cm , 20 cm , 3mm,18 cm , 20 cm ,
4mm,18 cm , 20 cm , 5mm,18 cm , 20 cm ,
6mm,

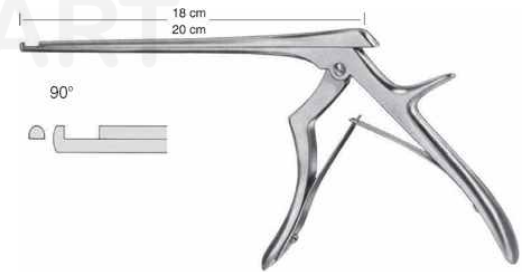

FERRIS-SMITH-KERRISON
AC-9-137-40

FERRIS-SMITH-KERRISON
18 cm , 20 cm , 1mm,18 cm , 20 cm ,
2mm,18 cm , 20 cm , 3mm,18 cm , 20 cm ,
4mm,18 cm , 20 cm , 5mm,18 cm , 20 cm ,
6mm,

Neurosurgery

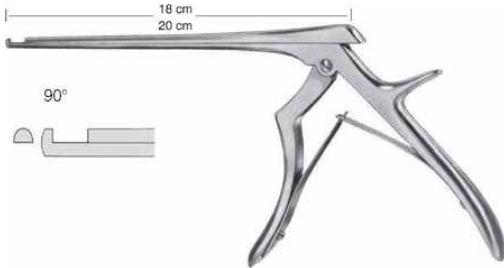

FERRIS-SMITH-KERRISON
AC-9-137-41

FERRIS-SMITH-KERRISON
18 cm , 20 cm , 1mm,18 cm , 20 cm ,
2mm,18 cm , 20 cm , 3mm,18 cm , 20 cm ,
4mm,18 cm , 20 cm , 5mm,18 cm , 20 cm ,
6mm,

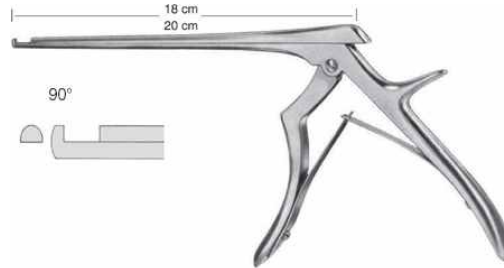

FERRIS-SMITH-KERRISON
AC-9-137-42

FERRIS-SMITH-KERRISON
18 cm , 20 cm , 1mm,18 cm , 20 cm ,
2mm,18 cm , 20 cm , 3mm,18 cm , 20 cm ,
4mm,18 cm , 20 cm , 5mm,18 cm , 20 cm ,
6mm,

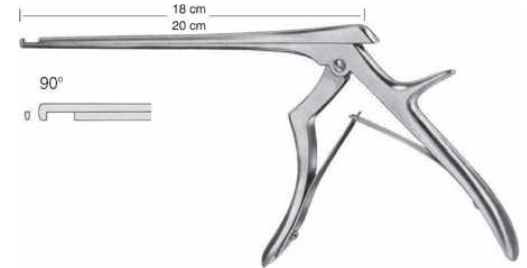

FERRIS-SMITH-KERRISON
AC-9-137-43

FERRIS-SMITH-KERRISON
18 cm , 20 cm , 1mm,18 cm , 20 cm ,
2mm,18 cm , 20 cm , 3mm,18 cm , 20 cm ,
4mm,18 cm , 20 cm , 5mm,18 cm , 20 cm ,
6mm,



FERRIS-SMITH-KERRISON
AC-9-137-44

FERRIS-SMITH-KERRISON
18 cm , 20 cm , 1mm,18 cm , 20 cm ,
2mm,18 cm , 20 cm , 3mm,18 cm , 20 cm ,
4mm,18 cm , 20 cm , 5mm,18 cm , 20 cm ,
6mm,

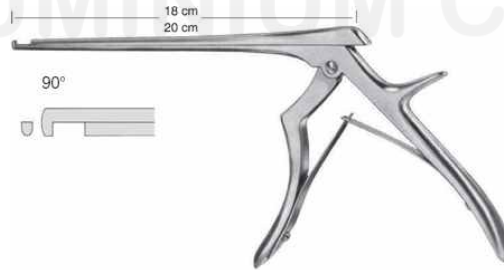

FERRIS-SMITH-KERRISON
AC-9-137-45

FERRIS-SMITH-KERRISON
18 cm , 20 cm , 1mm,18 cm , 20 cm ,
2mm,18 cm , 20 cm , 3mm,18 cm , 20 cm ,
4mm,18 cm , 20 cm , 5mm,18 cm , 20 cm ,
6mm,

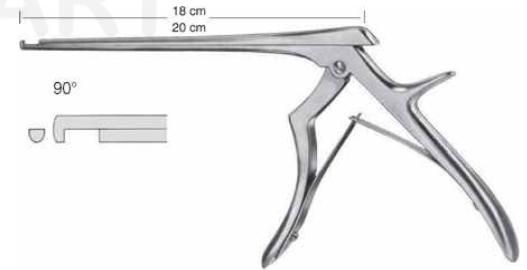

FERRIS-SMITH-KERRISON
AC-9-137-46

FERRIS-SMITH-KERRISON
18 cm , 20 cm , 1mm,18 cm , 20 cm ,
2mm,18 cm , 20 cm , 3mm,18 cm , 20 cm ,
4mm,18 cm , 20 cm , 5mm,18 cm , 20 cm ,
6mm,

Neurosurgery

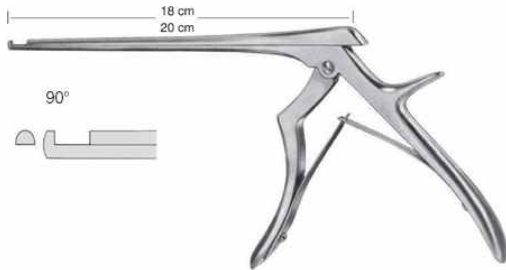

FERRIS-SMITH-KERRISON
AC-9-137-41

FERRIS-SMITH-KERRISON
18 cm , 20 cm , 1mm,18 cm , 20 cm ,
2mm,18 cm , 20 cm , 3mm,18 cm , 20 cm ,
4mm,18 cm , 20 cm , 5mm,18 cm , 20 cm ,
6mm,

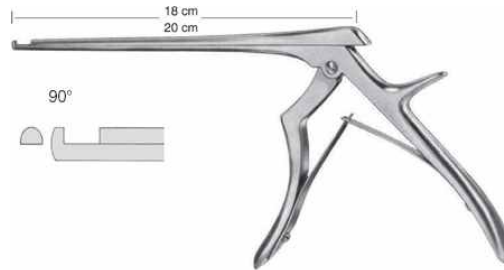

FERRIS-SMITH-KERRISON
AC-9-137-42

FERRIS-SMITH-KERRISON
18 cm , 20 cm , 1mm,18 cm , 20 cm ,
2mm,18 cm , 20 cm , 3mm,18 cm , 20 cm ,
4mm,18 cm , 20 cm , 5mm,18 cm , 20 cm ,
6mm,

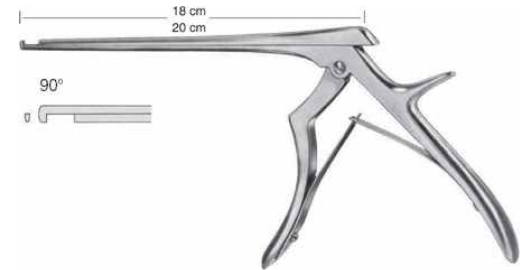

FERRIS-SMITH-KERRISON
AC-9-137-43

FERRIS-SMITH-KERRISON
18 cm , 20 cm , 1mm,18 cm , 20 cm ,
2mm,18 cm , 20 cm , 3mm,18 cm , 20 cm ,
4mm,18 cm , 20 cm , 5mm,18 cm , 20 cm ,
6mm,

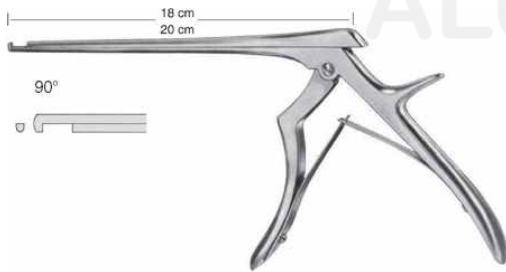

FERRIS-SMITH-KERRISON
AC-9-137-44

FERRIS-SMITH-KERRISON
18 cm , 20 cm , 1mm,18 cm , 20 cm ,
2mm,18 cm , 20 cm , 3mm,18 cm , 20 cm ,
4mm,18 cm , 20 cm , 5mm,18 cm , 20 cm ,
6mm,

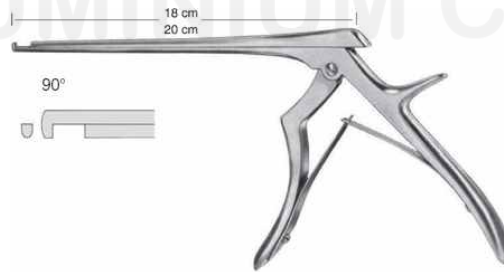

FERRIS-SMITH-KERRISON
AC-9-137-45

FERRIS-SMITH-KERRISON
18 cm , 20 cm , 1mm,18 cm , 20 cm ,
2mm,18 cm , 20 cm , 3mm,18 cm , 20 cm ,
4mm,18 cm , 20 cm , 5mm,18 cm , 20 cm ,
6mm,

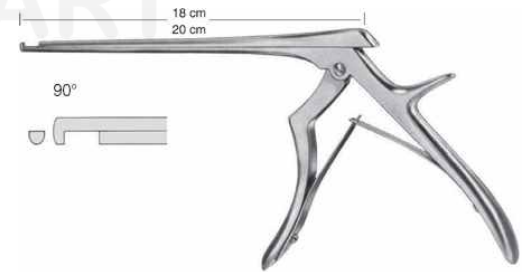

FERRIS-SMITH-KERRISON
AC-9-137-46

FERRIS-SMITH-KERRISON
18 cm , 20 cm , 1mm,18 cm , 20 cm ,
2mm,18 cm , 20 cm , 3mm,18 cm , 20 cm ,
4mm,18 cm , 20 cm , 5mm,18 cm , 20 cm ,
6mm,

Neurosurgery

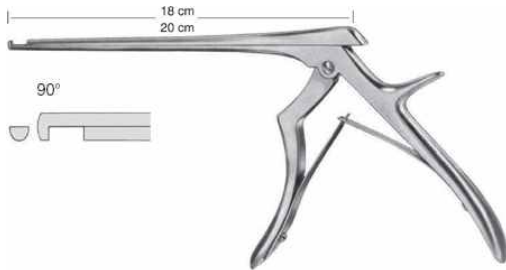

FERRIS-SMITH-KERRISON
AC-9-137-47

FERRIS-SMITH-KERRISON
18 cm , 20 cm , 1mm,18 cm , 20 cm ,
2mm,18 cm , 20 cm , 3mm,18 cm , 20 cm ,
4mm,18 cm , 20 cm , 5mm,18 cm , 20 cm ,
6mm,

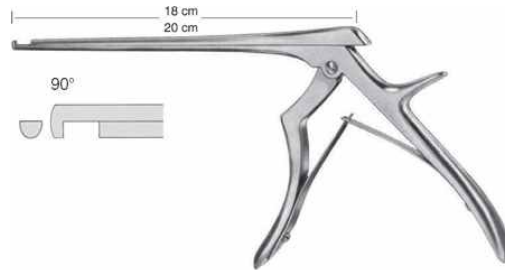

FERRIS-SMITH-KERRISON
AC-9-137-48

FERRIS-SMITH-KERRISON
18 cm , 20 cm , 1mm,18 cm , 20 cm ,
2mm,18 cm , 20 cm , 3mm,18 cm , 20 cm ,
4mm,18 cm , 20 cm , 5mm,18 cm , 20 cm ,
6mm,

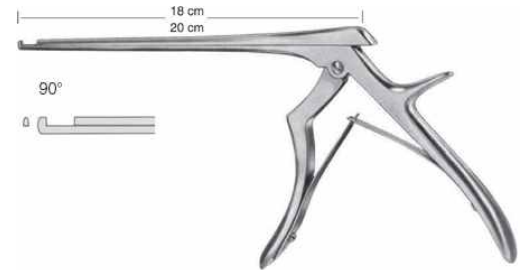

FERRIS-SMITH-KERRISON
AC-9-137-49

FERRIS-SMITH-KERRISON
18 cm , 20 cm , 1mm,18 cm , 20 cm ,
2mm,18 cm , 20 cm , 3mm,18 cm , 20 cm ,
4mm,18 cm , 20 cm , 5mm,18 cm , 20 cm ,
6mm,

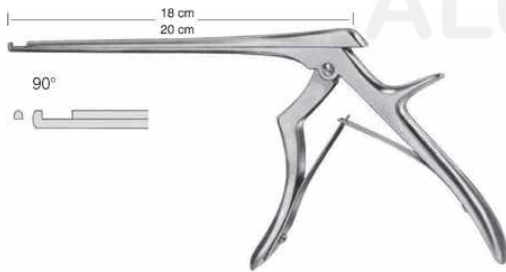

FERRIS-SMITH-KERRISON
AC-9-137-50

FERRIS-SMITH-KERRISON
18 cm , 20 cm , 1mm,18 cm , 20 cm ,
2mm,18 cm , 20 cm , 3mm,18 cm , 20 cm ,
4mm,18 cm , 20 cm , 5mm,18 cm , 20 cm ,
6mm,

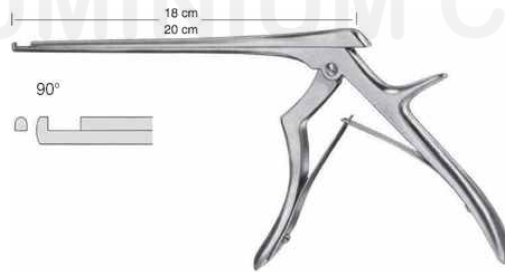

FERRIS-SMITH-KERRISON
AC-9-137-51

FERRIS-SMITH-KERRISON
18 cm , 20 cm , 1mm,18 cm , 20 cm ,
2mm,18 cm , 20 cm , 3mm,18 cm , 20 cm ,
4mm,18 cm , 20 cm , 5mm,18 cm , 20 cm ,
6mm,

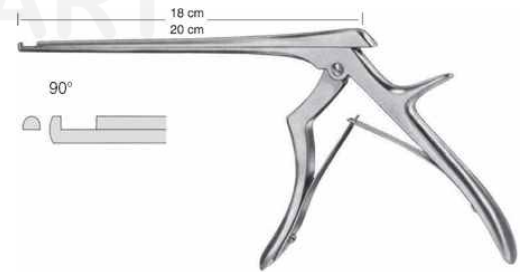

FERRIS-SMITH-KERRISON
AC-9-137-52

FERRIS-SMITH-KERRISON
18 cm , 20 cm , 1mm,18 cm , 20 cm ,
2mm,18 cm , 20 cm , 3mm,18 cm , 20 cm ,
4mm,18 cm , 20 cm , 5mm,18 cm , 20 cm ,
6mm,

Neurosurgery

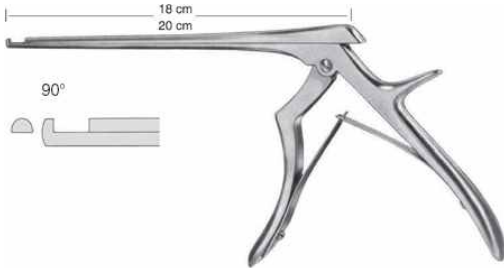

FERRIS-SMITH-KERRISON

AC-9-137-53

FERRIS-SMITH-KERRISON

18 cm , 20 cm , 1mm,18 cm , 20 cm ,
2mm,18 cm , 20 cm , 3mm,18 cm , 20 cm ,
4mm,18 cm , 20 cm , 5mm,18 cm , 20 cm ,
6mm,

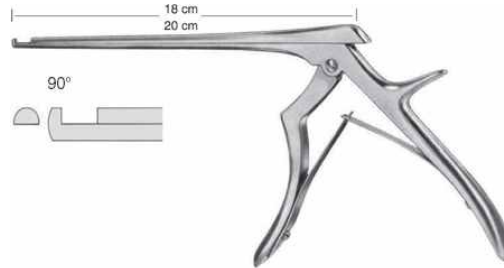

FERRIS-SMITH-KERRISON

AC-9-137-54

FERRIS-SMITH-KERRISON

18 cm , 20 cm , 1mm,18 cm , 20 cm ,
2mm,18 cm , 20 cm , 3mm,18 cm , 20 cm ,
4mm,18 cm , 20 cm , 5mm,18 cm , 20 cm ,
6mm,

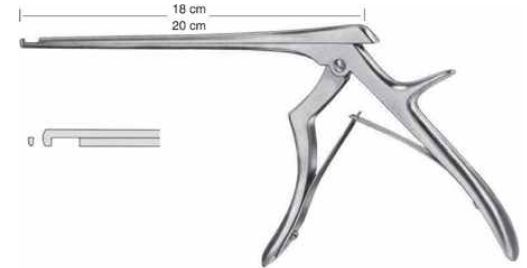

FERRIS-SMITH-KERRISON

AC-9-137-55

FERRIS-SMITH-KERRISON

18 cm , 20 cm , 1mm,18 cm , 20 cm ,
2mm,18 cm , 20 cm , 3mm,18 cm , 20 cm ,
4mm,18 cm , 20 cm , 5mm,18 cm , 20 cm ,
6mm,

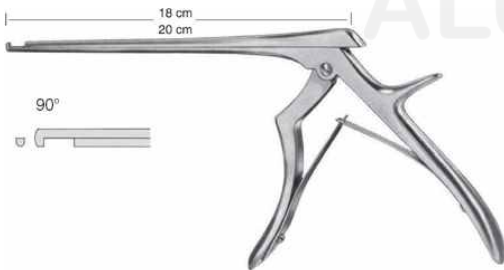

FERRIS-SMITH-KERRISON

AC-9-137-56

FERRIS-SMITH-KERRISON

18 cm , 20 cm , 1mm,18 cm , 20 cm ,
2mm,18 cm , 20 cm , 3mm,18 cm , 20 cm ,
4mm,18 cm , 20 cm , 5mm,18 cm , 20 cm ,
6mm,

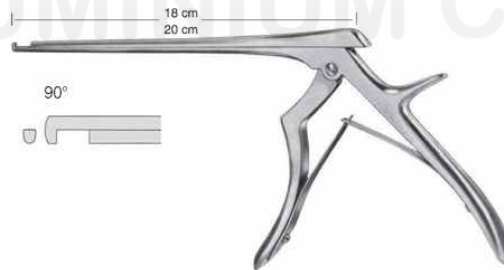

FERRIS-SMITH-KERRISON

AC-9-137-57

FERRIS-SMITH-KERRISON

18 cm , 20 cm , 1mm,18 cm , 20 cm ,
2mm,18 cm , 20 cm , 3mm,18 cm , 20 cm ,
4mm,18 cm , 20 cm , 5mm,18 cm , 20 cm ,
6mm,

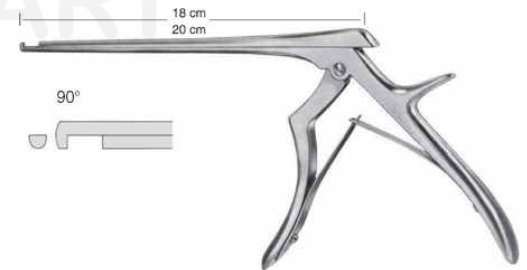

FERRIS-SMITH-KERRISON

AC-9-137-58

FERRIS-SMITH-KERRISON

18 cm , 20 cm , 1mm,18 cm , 20 cm ,
2mm,18 cm , 20 cm , 3mm,18 cm , 20 cm ,
4mm,18 cm , 20 cm , 5mm,18 cm , 20 cm ,
6mm,

Neurosurgery

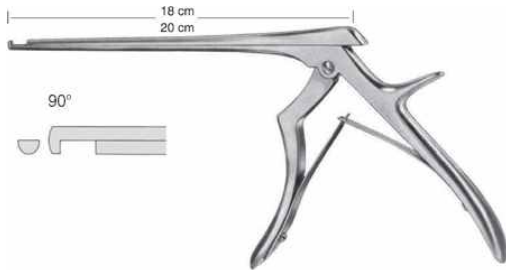

FERRIS-SMITH-KERRISON

AC-9-137-59

FERRIS-SMITH-KERRISON

18 cm , 20 cm , 1mm,18 cm , 20 cm ,
2mm,18 cm , 20 cm , 3mm,18 cm , 20 cm ,
4mm,18 cm , 20 cm , 5mm,18 cm , 20 cm ,
6mm,

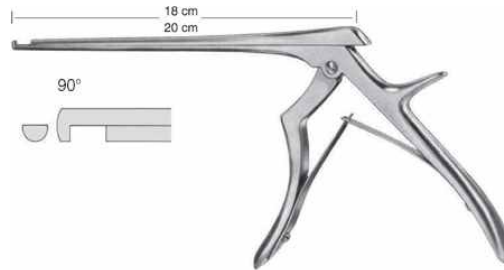

FERRIS-SMITH-KERRISON

AC-9-137-60

FERRIS-SMITH-KERRISON

18 cm , 20 cm , 1mm,18 cm , 20 cm ,
2mm,18 cm , 20 cm , 3mm,18 cm , 20 cm ,
4mm,18 cm , 20 cm , 5mm,18 cm , 20 cm ,
6mm,

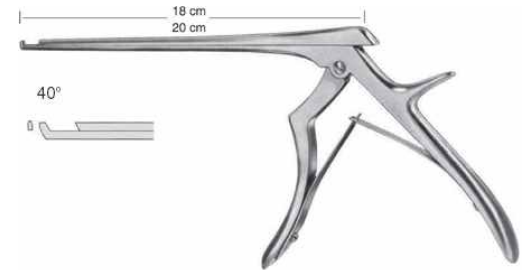

FERRIS-SMITH-KERRISON

AC-9-137-61

FERRIS-SMITH-KERRISON

18 cm , 20 cm , 1mm,18 cm , 20 cm ,
2mm,18 cm , 20 cm , 3mm,18 cm , 20 cm ,
4mm,18 cm , 20 cm , 5mm,18 cm , 20 cm ,
6mm,

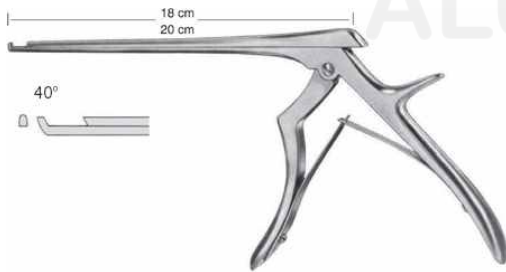

FERRIS-SMITH-KERRISON

AC-9-137-62

FERRIS-SMITH-KERRISON

18 cm , 20 cm , 1mm,18 cm , 20 cm ,
2mm,18 cm , 20 cm , 3mm,18 cm , 20 cm ,
4mm,18 cm , 20 cm , 5mm,18 cm , 20 cm ,
6mm,

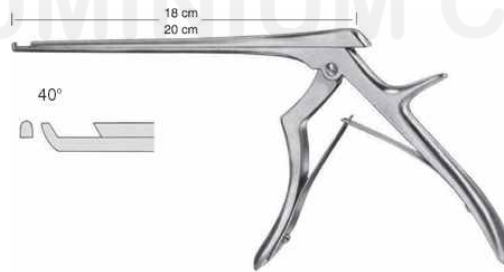

FERRIS-SMITH-KERRISON

AC-9-137-63

FERRIS-SMITH-KERRISON

18 cm , 20 cm , 1mm,18 cm , 20 cm ,
2mm,18 cm , 20 cm , 3mm,18 cm , 20 cm ,
4mm,18 cm , 20 cm , 5mm,18 cm , 20 cm ,
6mm,

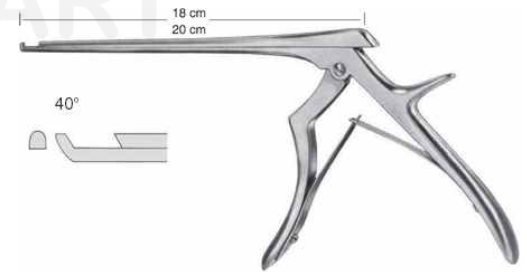

FERRIS-SMITH-KERRISON

AC-9-137-64

FERRIS-SMITH-KERRISON

18 cm , 20 cm , 1mm,18 cm , 20 cm ,
2mm,18 cm , 20 cm , 3mm,18 cm , 20 cm ,
4mm,18 cm , 20 cm , 5mm,18 cm , 20 cm ,
6mm,

Neurosurgery

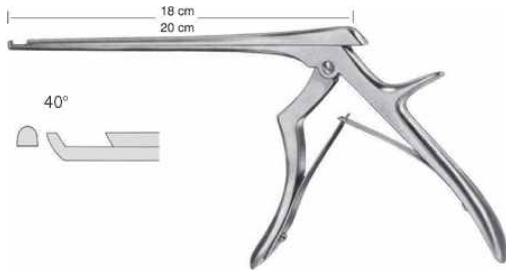

FERRIS-SMITH-KERRISON
AC-9-137-65

FERRIS-SMITH-KERRISON
18 cm , 20 cm , 1mm,18 cm , 20 cm ,
2mm,18 cm , 20 cm , 3mm,18 cm , 20 cm ,
4mm,18 cm , 20 cm , 5mm,18 cm , 20 cm ,
6mm,

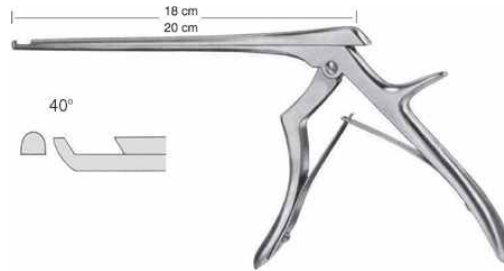

FERRIS-SMITH-KERRISON
AC-9-137-66

FERRIS-SMITH-KERRISON
18 cm , 20 cm , 1mm,18 cm , 20 cm ,
2mm,18 cm , 20 cm , 3mm,18 cm , 20 cm ,
4mm,18 cm , 20 cm , 5mm,18 cm , 20 cm ,
6mm,

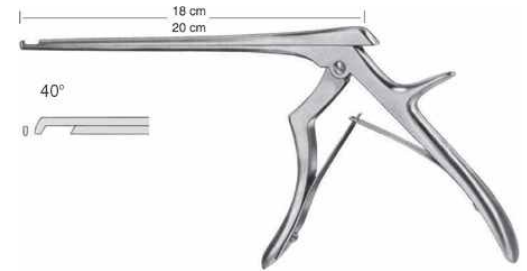

FERRIS-SMITH-KERRISON
AC-9-137-67

FERRIS-SMITH-KERRISON
18 cm , 20 cm , 1mm,18 cm , 20 cm ,
2mm,18 cm , 20 cm , 3mm,18 cm , 20 cm ,
4mm,18 cm , 20 cm , 5mm,18 cm , 20 cm ,
6mm,

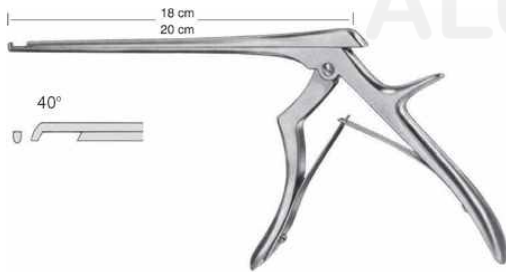

FERRIS-SMITH-KERRISON
AC-9-137-68

FERRIS-SMITH-KERRISON
18 cm , 20 cm , 1mm,18 cm , 20 cm ,
2mm,18 cm , 20 cm , 3mm,18 cm , 20 cm ,
4mm,18 cm , 20 cm , 5mm,18 cm , 20 cm ,
6mm,

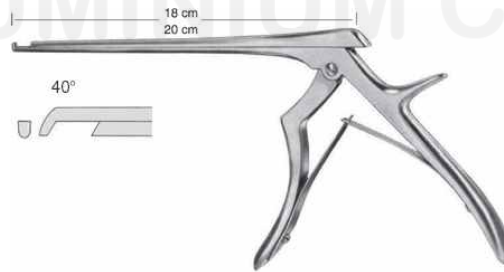

FERRIS-SMITH-KERRISON
AC-9-137-69

FERRIS-SMITH-KERRISON
18 cm , 20 cm , 1mm,18 cm , 20 cm ,
2mm,18 cm , 20 cm , 3mm,18 cm , 20 cm ,
4mm,18 cm , 20 cm , 5mm,18 cm , 20 cm ,
6mm,

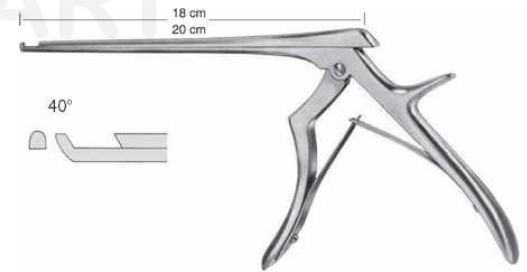

FERRIS-SMITH-KERRISON
AC-9-137-70

FERRIS-SMITH-KERRISON
18 cm , 20 cm , 1mm,18 cm , 20 cm ,
2mm,18 cm , 20 cm , 3mm,18 cm , 20 cm ,
4mm,18 cm , 20 cm , 5mm,18 cm , 20 cm ,
6mm,

Neurosurgery

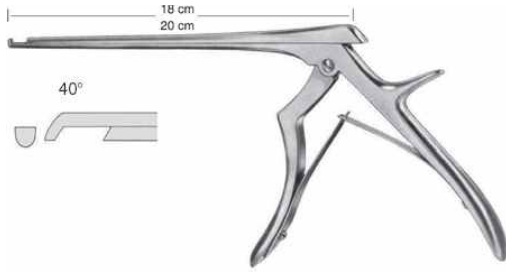

FERRIS-SMITH-KERRISON
AC-9-137-71

FERRIS-SMITH-KERRISON
18 cm , 20 cm , 1mm,18 cm , 20 cm ,
2mm,18 cm , 20 cm , 3mm,18 cm , 20 cm ,
4mm,18 cm , 20 cm , 5mm,18 cm , 20 cm ,
6mm,

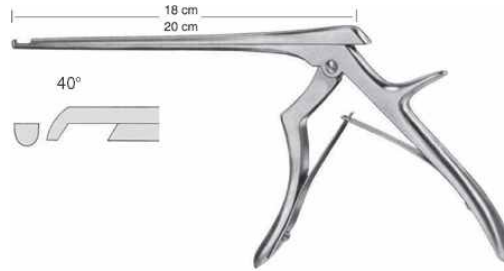

FERRIS-SMITH-KERRISON
AC-9-137-72

FERRIS-SMITH-KERRISON
18 cm , 20 cm , 1mm,18 cm , 20 cm ,
2mm,18 cm , 20 cm , 3mm,18 cm , 20 cm ,
4mm,18 cm , 20 cm , 5mm,18 cm , 20 cm ,
6mm,

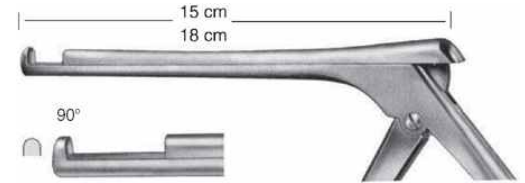

COLCLOUGH
AC-9-137-73

COLCLOUGH
3 mm
5 mm

15 cm,18 cm,



COLCLOUGH
AC-9-137-74
COLCLOUGH
3 mm
5 mm
15 cm,18 cm,



COLCLOUGH
AC-9-137-75
COLCLOUGH
3 mm
5 mm
20 cm,



COLCLOUGH
AC-9-137-76
COLCLOUGH
3 mm
5 mm
20 cm,

Neurosurgery

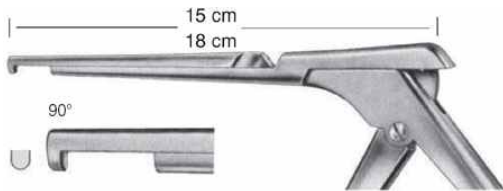

COLCLOUGH
AC-9-137-77
COLCLOUGH
3 mm
5 mm
15 cm, 18 cm,

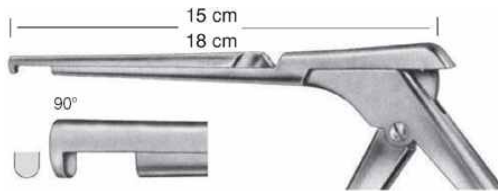

COLCLOUGH
AC-9-137-78
COLCLOUGH
3 mm
5 mm
15 cm, 18 cm,

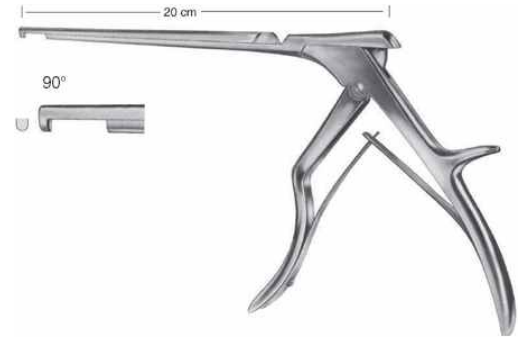

COLCLOUGH
AC-9-137-79
COLCLOUGH
3 mm
5 mm
20 cm,

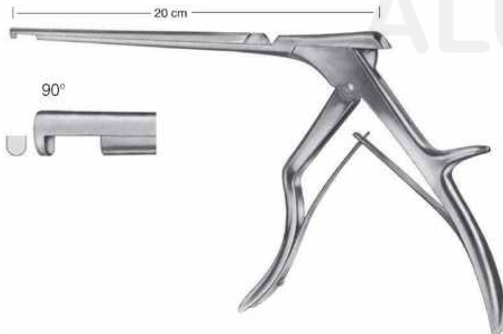

COLCLOUGH
AC-9-137-80
COLCLOUGH
3 mm
5 mm
20 cm,



COLCLOUGH
AC-9-137-81
COLCLOUGH
3 mm
5 mm
15 cm, 18 cm,

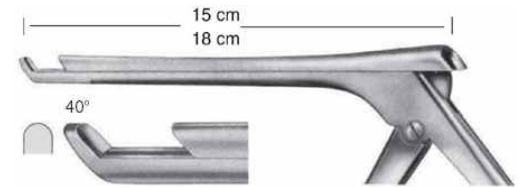

COLCLOUGH
AC-9-137-82
COLCLOUGH
3 mm
5 mm
15 cm, 18 cm,

Neurosurgery

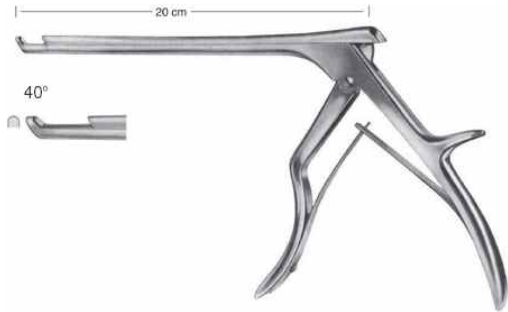

COLCLOUGH
AC-9-137-83
COLCLOUGH
3 mm
5 mm
20 cm,

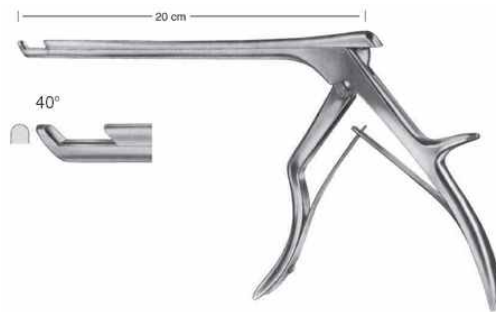

COLCLOUGH
AC-9-137-84
COLCLOUGH
3 mm
5 mm
20 cm,

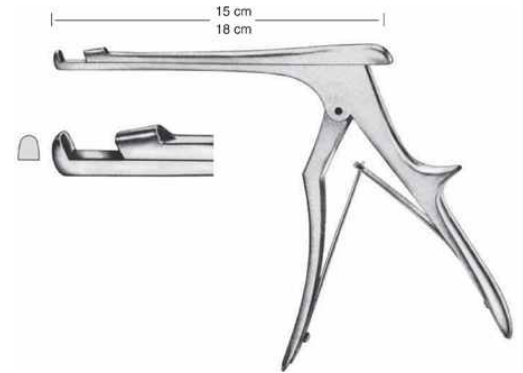

RANEY
AC-9-137-85
RANEY
15 cm / 6mm, 18 cm / 6mm,

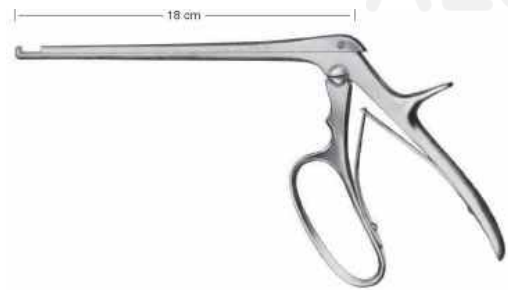

FERRIS-SMITH-KERRISON
AC-9-137-86
FERRIS-SMITH-KERRISON
18 cm,



FERRIS-SMITH-KERRISON
AC-9-137-87
FERRIS-SMITH-KERRISON
3x3 mm,

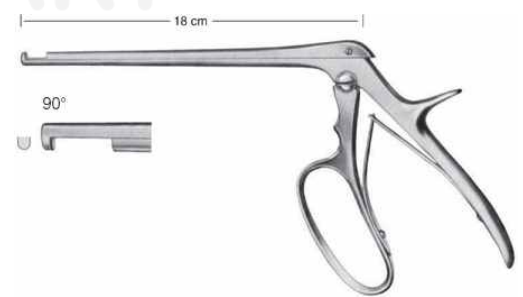

FERRIS-SMITH-KERRISON
AC-9-137-88
FERRIS-SMITH-KERRISON
3x3 mm,

Neurosurgery

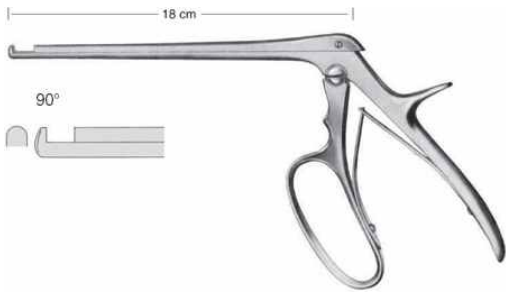

FERRIS-SMITH-KERRISON
AC-9-137-89
FERRIS-SMITH-KERRISON
5x5 mm,

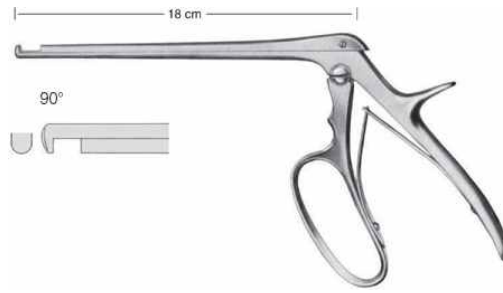

FERRIS-SMITH-KERRISON
AC-9-137-90
FERRIS-SMITH-KERRISON
5x5 mm,

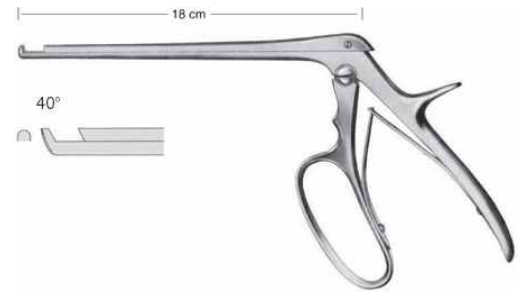

FERRIS-SMITH-KERRISON
AC-9-137-91
FERRIS-SMITH-KERRISON
3 mm,

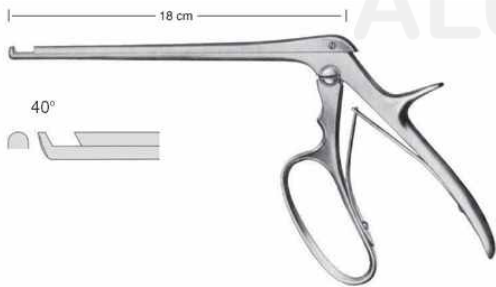

FERRIS-SMITH-KERRISON
AC-9-137-92
FERRIS-SMITH-KERRISON
5 mm,



FERRIS-SMITH-CUSACNG
AC-9-137-93
FERRIS-SMITH-CUSACNG
18 cm,

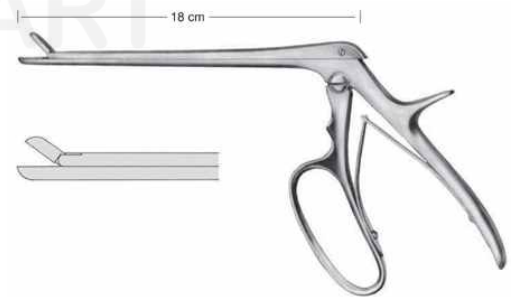

FERRIS-SMITH-CUSACNG
AC-9-137-94
FERRIS-SMITH-CUSACNG
2 x 10 mm, 3 x 10 mm, 4 x 10 mm, 5 x 10 mm, 6 x 10 mm,

Neurosurgery

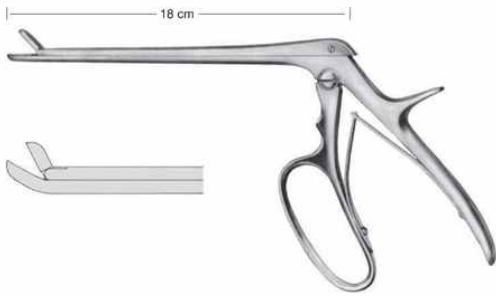

FERRIS-SMITH-CUSACNG
AC-9-137-95
FERRIS-SMITH-CUSACNG
2 x 10 mm, 3 x 10 mm, 4 x 10 mm, 5 x 10 mm, 6 x 10 mm,

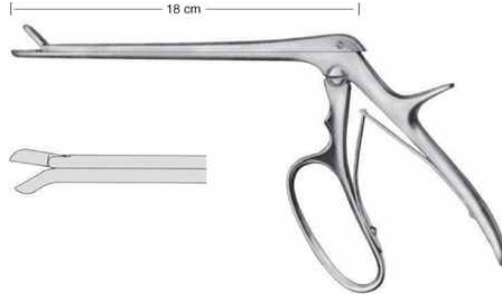

FERRIS-SMITH-CUSACNG
AC-9-137-96
FERRIS-SMITH-CUSACNG
2 x 10 mm, 3 x 10 mm, 4 x 10 mm, 5 x 10 mm, 6 x 10 mm,

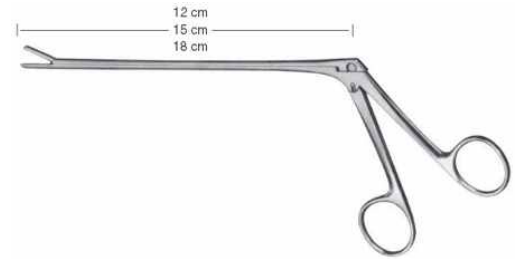

CUSACNG
AC-9-137-97
CUSACNG

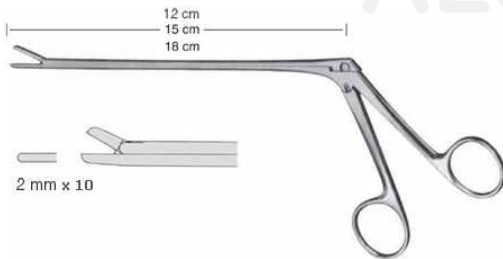

CUSACNG
AC-9-137-98
CUSACNG
2 mm x 10, 12 cm, 15 cm, 18 cm,

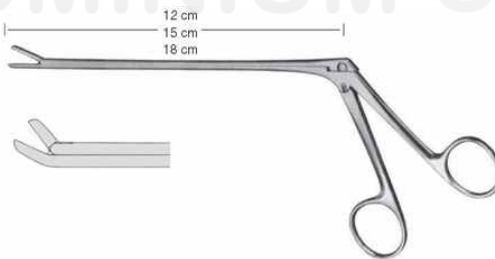

CUSACNG
AC-9-137-99
CUSACNG
2 mm x 10, 12 cm, 15 cm, 18 cm,

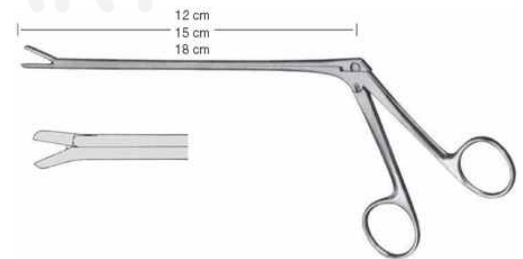

CUSACNG
AC-9-137-100
CUSACNG
2 mm x 10, 12 cm, 15 cm, 18 cm,

ALUMINIUM CART

Neurosurgery

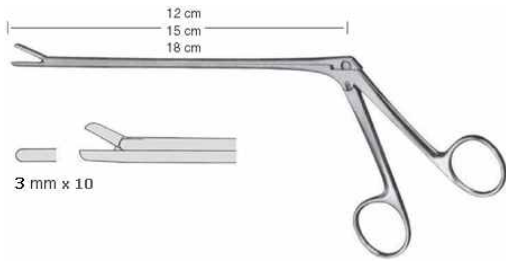

LOVE-GRUENWALD
AC-9-137-101
LOVE-GRUENWALD
3 mm x 10, 12 cm, 15 cm, 18 cm,

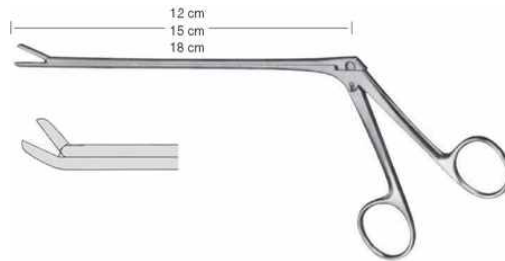

LOVE-GRUENWALD
AC-9-137-102
LOVE-GRUENWALD
3 mm x 10, 12 cm, 15 cm, 18 cm,

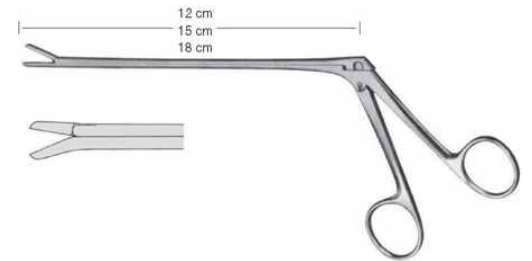

LOVE-GRUENWALD
AC-9-137-103
LOVE-GRUENWALD
3 mm x 10, 12 cm, 15 cm, 18 cm,

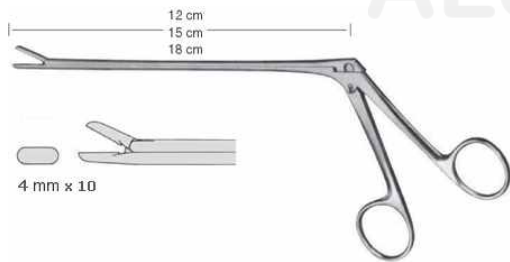

SPURLING
AC-9-137-104
SPURLING
4 mm x 10, 12 cm, 15 cm, 18 cm,

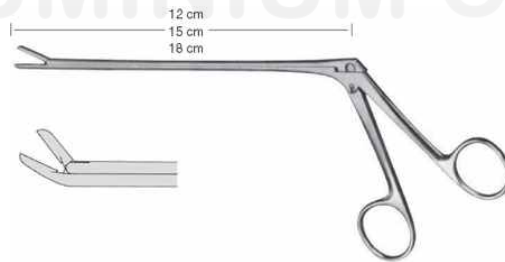

SPURLING
AC-9-137-105
SPURLING
4 mm x 10, 12 cm, 15 cm, 18 cm,

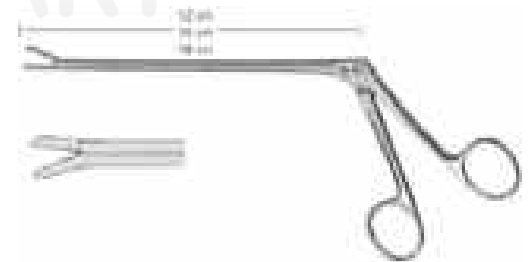

SPURLING
AC-9-137-106
SPURLING
4 mm x 10, 12 cm, 15 cm, 18 cm,

Neurosurgery



OLDACRG
AC-9-137-107
OLDACRG
18 cm,



SCHLESINGER
AC-9-137-108
SCHLESINGER
15 cm, 2 x 10 mm, 3 x 10 mm, 4 x 10 mm, 5 x 10 mm,



CACPAR
AC-9-137-109
CACPAR
2 mm, 14 cm, 15 cm, 16 cm, 18.5 cm,



CACPAR
AC-9-137-110
CACPAR
3 mm, 14 cm, 15 cm, 16 cm, 18.5 cm,



CACPAR
AC-9-137-111
CACPAR
4 mm, 14 cm, 15 cm, 16 cm, 18.5 cm,



CACPAR
AC-9-137-112
CACPAR
5 mm, 14 cm, 15 cm, 16 cm, 18.5 cm,

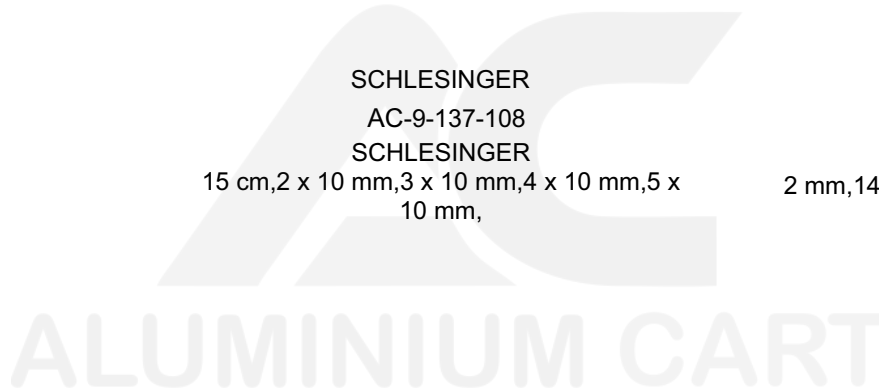

Neurosurgery



CACPAR
AC-9-137-113
CACPAR
2 mm, 14 cm, 15 cm, 16 cm, 18.5 cm,



CACPAR
AC-9-137-114
CACPAR
3 mm, 14 cm, 15 cm, 16 cm, 18.5 cm,



CACPAR
AC-9-137-115
CACPAR
4 mm, 14 cm, 15 cm, 16 cm, 18.5 cm,



CACPAR
AC-9-137-116
CACPAR
2 mm, 14 cm, 15 cm, 16 cm, 18.5 cm,



CACPAR
AC-9-137-117
CACPAR
3 mm, 14 cm, 15 cm, 16 cm, 18.5 cm,



CACPAR
AC-9-137-118
CACPAR
4 mm, 14 cm, 15 cm, 16 cm, 18.5 cm,

Neurosurgery



YACARGIL
AC-9-137-119
YACARGIL
25 cm, 2.2 cm, 3.5 cm, 4.0 cm,

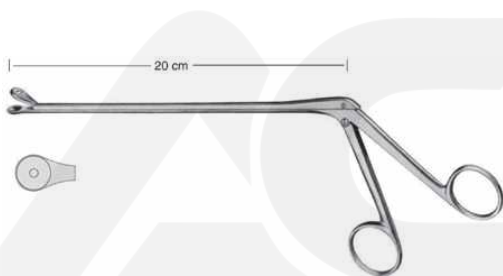

LANDOLT
AC-9-137-120
LANDOLT
27 cm, 9 mm,



OLIVECRONA-TOENNIS
AC-9-137-121
14 cm,

ALUMINIUM CART

Cardiovascular



AC-9-101-23
Bone Shear
23 cm,



AC-9-102-22
Rib Shear
23 cm,



Gluck
AC-9-103-22
Rib Shears
21 cm,



Giertz-Stille
AC-9-104-27
Rib Shear
24.5 cm,



Lebsche
AC-9-105-24
Sternum Chisel
24.5 cm,



AC-9-106-01
Rib Retractor lateral blades 12 x 16 mm
spreading 95 mm
Size 1,

Cardiovascular



Finochietto, Infant
AC-9-107-01
Rib Retractor lateral blades 15 x 15 mm
spreading 75 mm
Size 1,



Finochietto, Baby
AC-9-108-01
Rib Retractor lateral blades 31 x 31 mm
spreading 100 mm
Size 1,



Finochietto
AC-9-109-01
Rib Retractor lateral blades 40 x 45 mm
spreading 135 mm
Size 1,



Burford
AC-9-110-01
Rib Retractor with two pairs of blades 47 x 62
mm + 65 x 62 mm, spreading 200 mm
Size 1,



Castaneda
AC-9-111-01
Rib Retractor lateral blades 10,5 x 32 mm
spreading 65 mm
Size 1,



Finochietto (modif.)
AC-9-112-01
Rib Retractor lateral blades 14 x 15 mm
spreading 120 mm
Size 1,

Cardiovascular



Haight
AC-9-113-90
Rib Retractor lateral blades 30 x 30 mm
spreading 120 mm
Size 1,



Morse-Favaloro
AC-9-114-01
Sternal Retractor 4 movable blades 17 x 22
mm spreading 160 mm Sternal Retractor
Size 1,



Morse
AC-9-115-00
Sternal Retractor 4 movable blades 22 x 27
mm spreading 200 mm
Size 1,



Tuffier
AC-9-116-02
Rib Retractor lateral blades 22 x 27 mm
spreading 200 mm
Size 1,

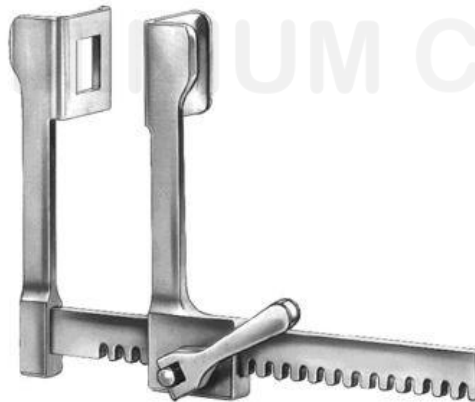

Finochietto, Baby
AC-9-117-75
Rib Retractor lateral blades 14 x 15 mm
spreading 75 mm
Size 1,



Finochietto
AC-9-118-01
Rib Retractor lateral blades 30 x 45 mm
spreading 150 mm
Size 1,

Cardiovascular



DeBakey
AC-9-119-00
Rib Retractor spreading 150 mm
Size 1,



DeBakey
AC-9-120-00
Rib Retractor spreading 200 mm
Size 1,



AC-9-121-00
Thoracic Retractor
Size 1,



Sellors
AC-9-122-19
Rib Contractor
20 cm,



Bailey-Baby
AC-9-123-14
Rib Contractor
15.5 cm,



Bailey
AC-9-124-16
Rib Contractor
20 cm,

Cardiovascular



Bailey-Gibbon
AC-9-125-16
Rib Contractor
20 cm,



Allison
AC-9-126-30
Lung Spatula
29.5 cm, 32.5 cm,



Price-Thomas
AC-9-127-22
Bronchus Clamp
22 cm,

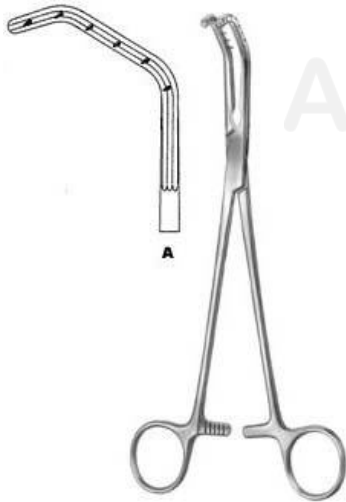

Price-Thomas
AC-9-128-22
Bronchus Clamp
22 cm,

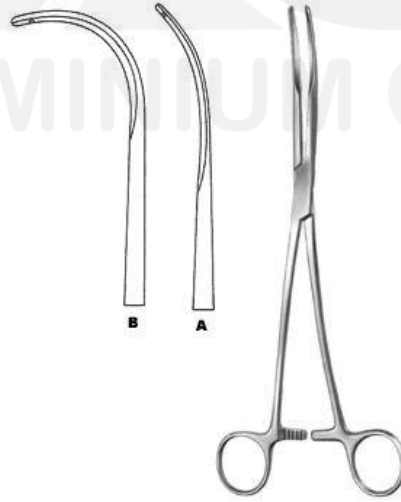

Semb
AC-9-129-24
Bronchus Clamp
24.5 cm,

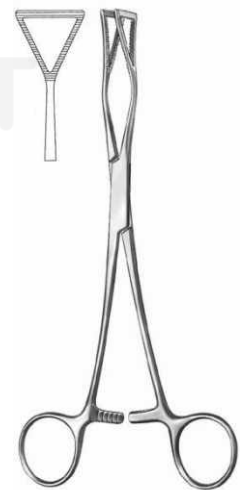

Lovlace
AC-9-130-20
Lung Grasping Forceps
20.5 cm,

Cardiovascular

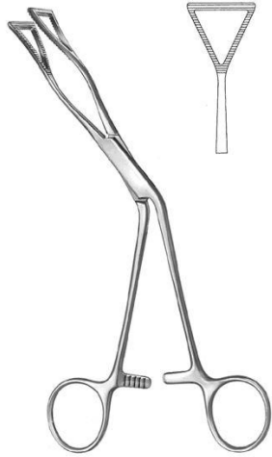

Lovelace
AC-9-131-20
Lung Grasping Forceps
19 cm,



DeBakey-Satinsky
AC-9-132-07
Bulldog Clamp
7 cm, 9 cm,



Glover
AC-9-133-06
Bulldog Clamp
6 cm,



Santulli
AC-9-134-07
Bulldog Clamp
7 cm,



Gregory, soft
AC-9-135-09
Bulldog Clamp
9 cm, 11 cm,



Gregory
AC-9-136-01
Bulldog Clamp
10.5 cm,



Cardiovascular

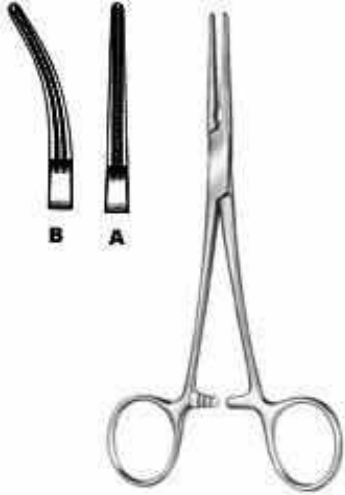

DeBakey-Rankin
AC-9-137-16
Haemostatic Forceps
16 cm,



DeBakey-Mosquito
AC-9-138-15
Haemostatic Forceps
15 cm,



Ochsner
AC-9-139-23
Aortic Clamp
23.5 cm,



Diethrich
AC-9-140-21
Aortic Clamp
22 cm,



Dardik
AC-9-141-00
Multi purpose Vascular Clamp
15 cm,



Dale
AC-9-142-18
Peripheral Vascular Clamp
18 cm,

Cardiovascular

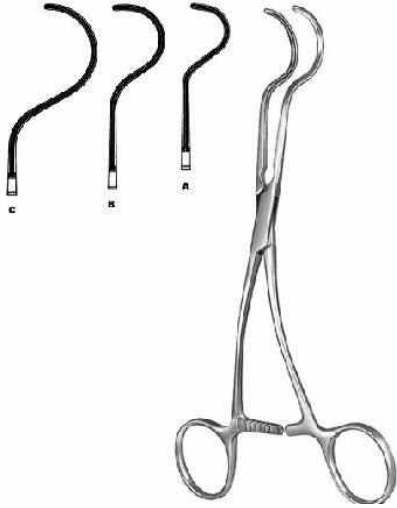

Dale
AC-9-143-17
Peripheral Vascular Clamp
17.5 cm,

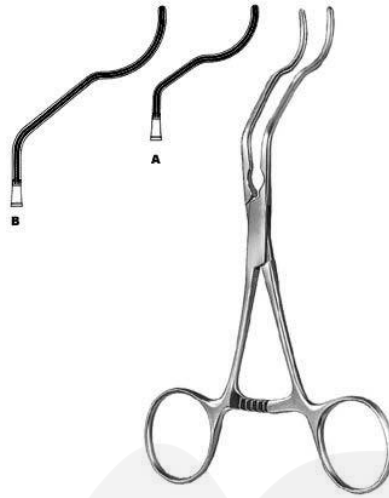

Gregory
AC-9-144-14
Profunda Clamp
13 cm, 16 cm, 18 cm,



Martin
AC-9-145-16
Peripheral Vascular Clamp
16.5 cm,



Husfeldt
AC-9-146-18
Peripheral Vascular Clamp
17.5 cm,



Husfeldt
AC-9-147-18
Peripheral Vascular Clamp
18 cm,



Husfeldt
AC-9-148-17
Peripheral Vascular Clamp
17 cm,



DeBakey
AC-9-149-16
Vascular Forceps
16 cm,



DeBakey
AC-9-150-16
Vascular Forceps
16 cm,



DeBakey
AC-9-151-16
Vascular Forceps
16 cm,

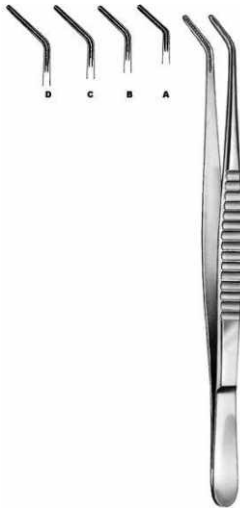

DeBakey
AC-9-152-16
Vascular Forceps
16 cm,



DeBakey
AC-9-153-16
Vascular Forceps
16 cm,



DeBakey
AC-9-154-07
Bulldog Clamp
7.5 cm,

Cardiovascular



DeBakey
AC-9-155-07
Bulldog Clamp
7.5 cm,



AC-9-156-23
Applying Forceps
23.5 cm,



Glover
AC-9-157-06
Bulldog Clamp
7 cm,



Glover
AC-9-158-06
Bulldog Clamp
6.5 cm,

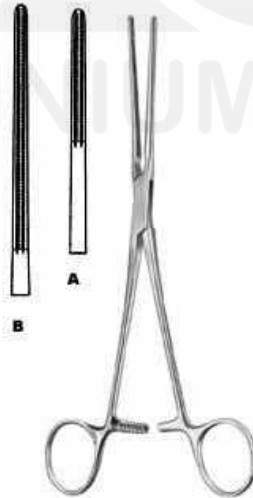

Potts
AC-9-159-21
Coarctation Clamp
21 cm,

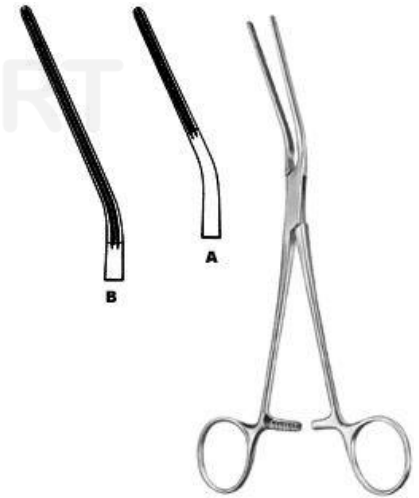

Potts
AC-9-160-21
Coarctation Clamp
20.5 cm,

Cardiovascular

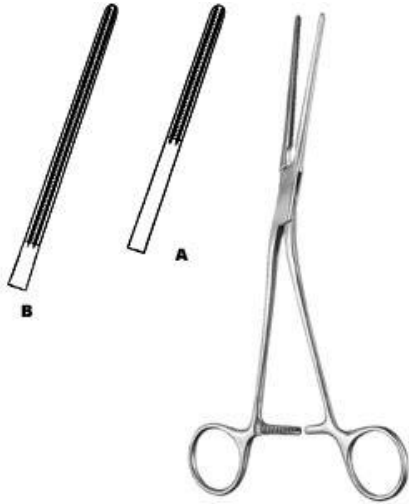

Potts
AC-9-161-21
Coarctation Clamp
20.5 cm,



Potts
AC-9-162-22
Anastomosis Clamp
21.5 cm,



Potts
AC-9-163-22
Anastomosis Clamp
22 cm,

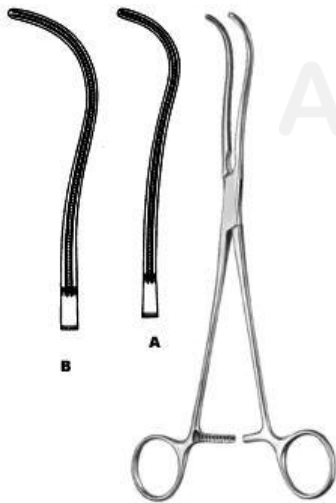

DeBakey
AC-9-164-19
Ligature Forceps
19 cm,



DeBakey
AC-9-165-16
Peripheral Vascular Clamp
16 cm,



DeBakey
AC-9-166-19
Peripheral Vascular Clamp
16 cm,

Cardiovascular

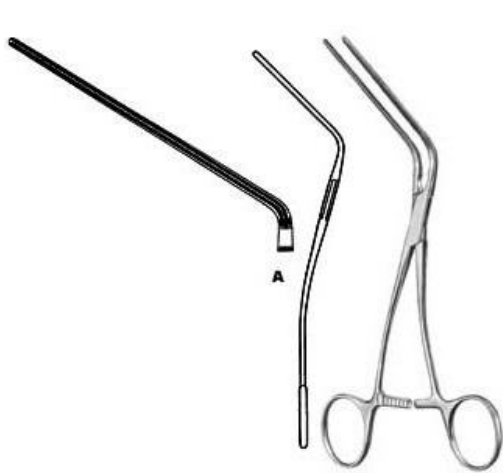

Leland-Jones
AC-9-167-18
Peripheral Vascular Clamp
18 cm,



Bainbridge
AC-9-168-15
Multi purpose Vascular Clamp
15 cm,



Bainbridge
AC-9-169-15
Multi purpose Vascular Clamp
15 cm,

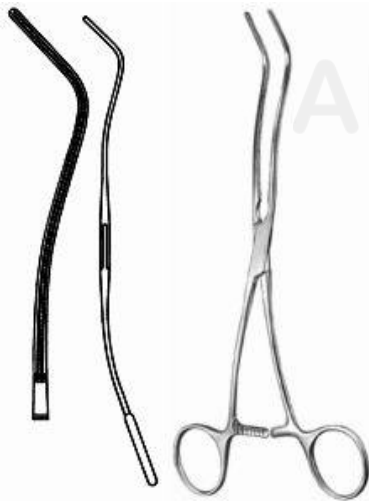

DeBakey
AC-9-170-20
Multi purpose Vascular Clamp
20 cm,



DeBakey
AC-9-171-26
Aortic Aneurysm Clamp
26 cm,



DeBakey
AC-9-172-28
Aortic Aneurysm Clamp
28 cm,

Cardiovascular



DeBakey
AC-9-173-30
Aortic Aneurysm Clamp
30 cm,



DeBakey
AC-9-174-27
Aortic Clamp
27 cm,



DeBakey
AC-9-175-24
Ligature Forceps
24.5 cm,



DeBakey
AC-9-176-24
Ligature Forceps
24.5 cm,



DeBakey
AC-9-178-25
Ligature Forceps
27 cm,

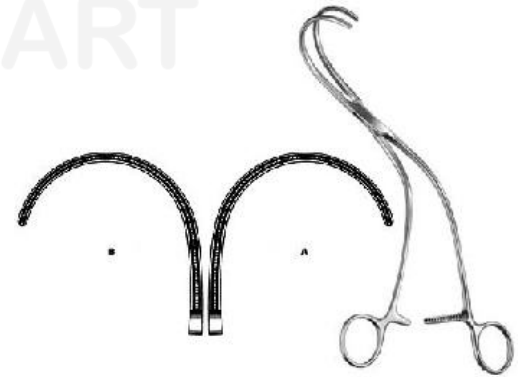

Weber
AC-9-179-01
Aortic Clamp
24 cm,

Cardiovascular



Satinsky
AC-9-180-20
Tangential Occlusion Clamp
22 cm,



Harken
AC-9-181-01
Auricle Clamp
24.5 cm,



Lees
AC-9-182-23
Bronchus Clamp
23 cm,



Lees
AC-9-183-25
Bronchus Clamp
25 cm,



Lambert-Kay
AC-9-184-21
Anastomosis Clamp
22.5 cm,



DeBakey
AC-9-185-17
Anastomosis Clamp
16.5 cm,

Cardiovascular



Morris-DeBakey
AC-9-186-18
Aortic Clamp
16.5 cm,



DeBakey-Bahnson
AC-9-187-23
Aneurysm Clamp
23.5 cm,

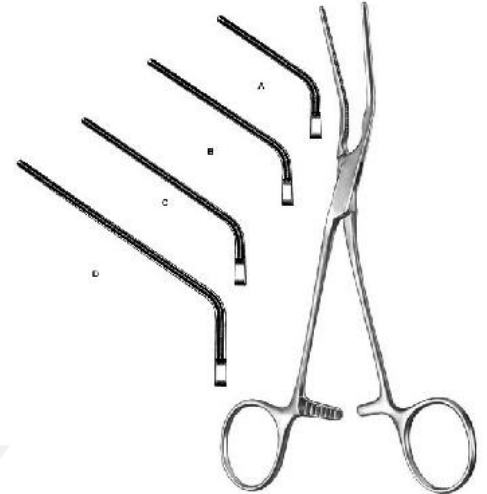

DeBakey
AC-9-188-20
Multi purpose Vascular Clamp
18 cm,

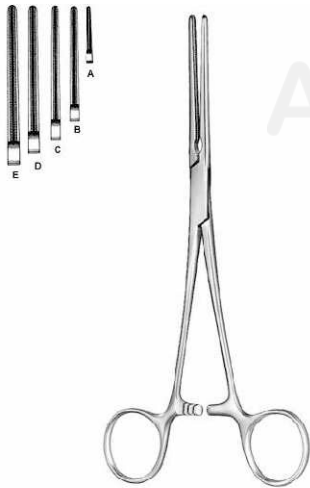

DeBakey-Mosquito
AC-9-189-12
Haemostatic Forceps
12.5 cm,



DeBakey-Mosquito
AC-9-190-12
Haemostatic Forceps
12.5 cm,



DeBakey
AC-9-191-17
Multi purpose Vascular Clamp
17 cm,

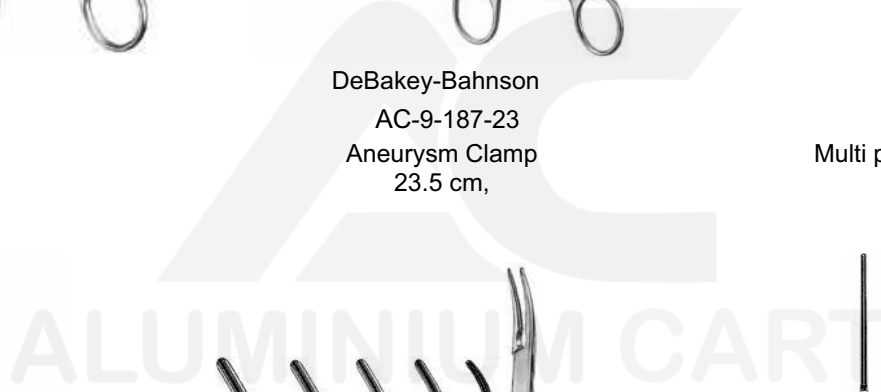

Cardiovascular



DeBakey
AC-9-192-16
Multi purpose Vascular Clamp
16.5 cm,

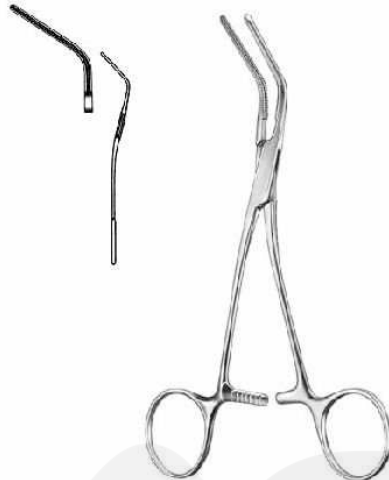

DeBakey
AC-9-193-15
Multi purpose Vascular Clamp
16 cm,

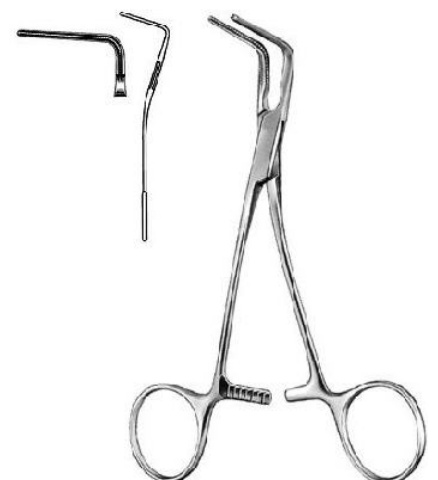

DeBakey
AC-9-194-15
Multi purpose Vascular Clamp
16.5 cm,



DeBakey
AC-9-195-17
Multi purpose Vascular Clamp
16.5 cm,



Glover
AC-9-196-17
Multi purpose Vascular Clamp
17 cm,



Glover
AC-9-197-17
Multi purpose Vascular Clamp
17.5 cm,

Cardiovascular

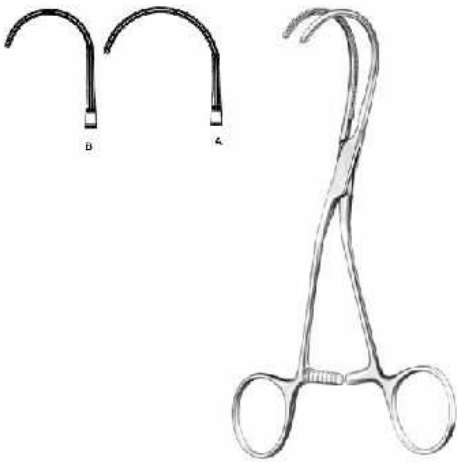

DeBakey
AC-9-198-16
Multi purpose Vascular Clamp
16.5 cm,

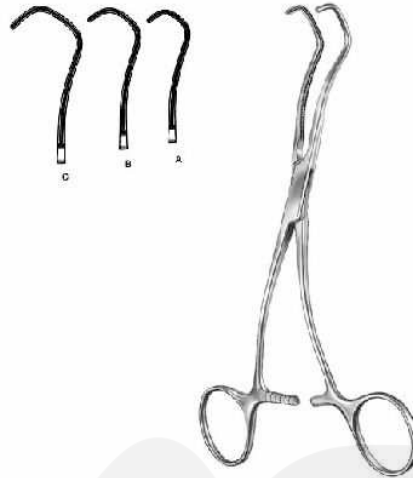

Derra
AC-9-199-16
Anastomosis Clamp
16.5 cm Fig. 1, 17 cm Fig. 2, 18 cm Fig. 3,



DeBakey-Beck
AC-9-200-17
Anastomosis Clamp
17 cm,



Cooley
AC-9-201-16
Vascular Forceps
16 cm,

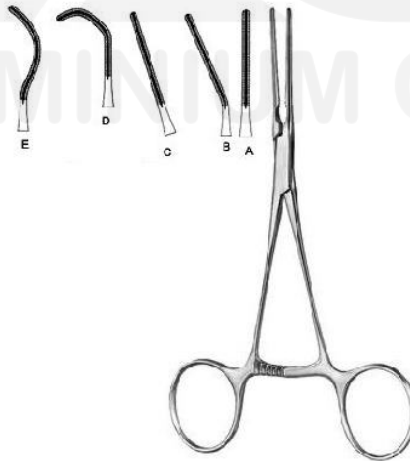

Cooley
AC-9-202-01
Pediatric Vascular Clamp
14.5 cm,

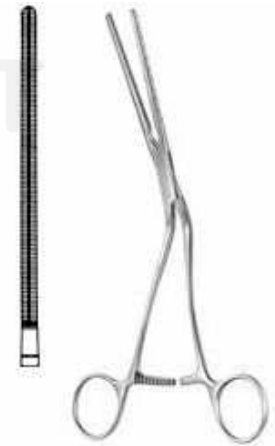

Cooley
AC-9-203-21
Iliac Clamp
22 cm,

Cardiovascular

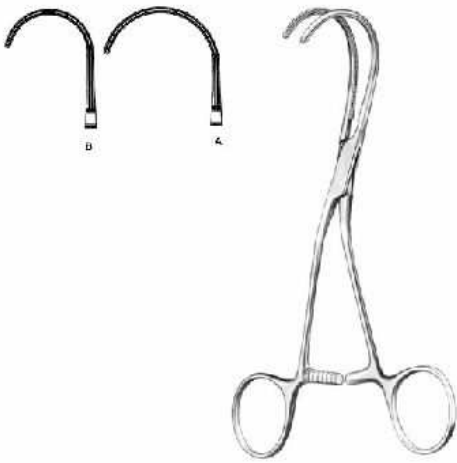

DeBakey
AC-9-198-16
Multi purpose Vascular Clamp
16.5 cm,

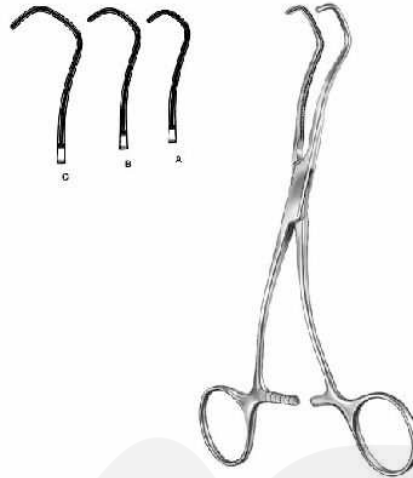

Derra
AC-9-199-16
Anastomosis Clamp
16.5 cm Fig. 1, 17 cm Fig. 2, 18 cm Fig. 3,



DeBakey-Beck
AC-9-200-17
Anastomosis Clamp
17 cm,



Cooley
AC-9-201-16
Vascular Forceps
16 cm,

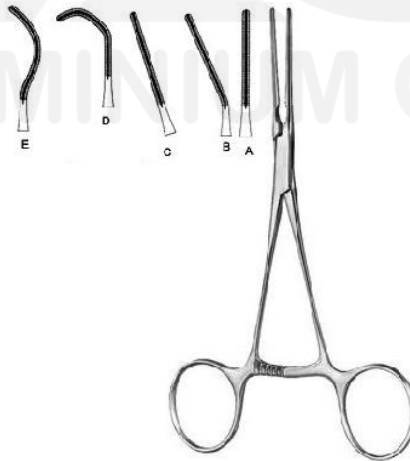

Cooley
AC-9-202-01
Pediatric Vascular Clamp
14.5 cm,

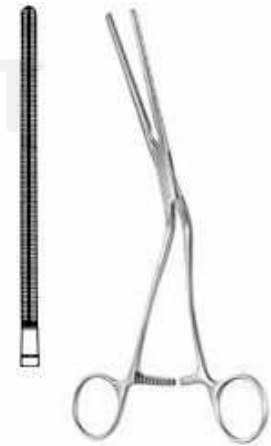

Cooley
AC-9-203-21
Iliac Clamp
22 cm,

Cardiovascular



Cooley
AC-9-204-17
Anastomosis Clamp
17 cm,

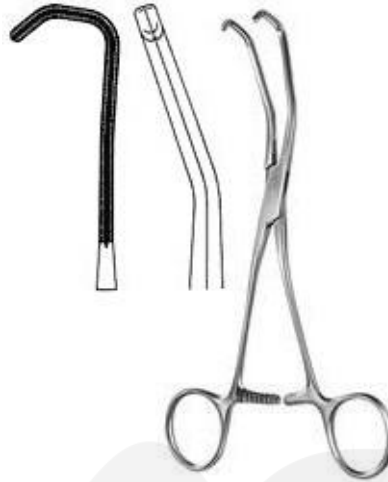

Cooley
AC-9-205-17
Anastomosis Clamp
20 cm,



Cooley
AC-9-206-16
Anastomosis Clamp
17 cm,



Cooley
AC-9-207-15
Multi purpose Vascular Clamp
16 cm,



Cooley
AC-9-208-17
Multi purpose Vascular Clamp
17 cm,



Cooley
AC-9-209-17
Multi purpose Vascular Clamp
17 cm,

Cardiovascular



Cooley
AC-9-210-17
Multi purpose Vascular Clamp
17.5 cm,

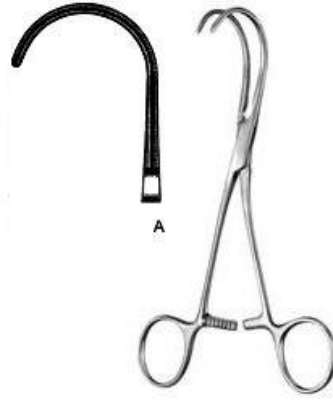

Cooley
AC-9-211-16
Multi purpose Vascular Clamp
16.5 cm,



Cooley-Derra
AC-9-212-16
Anastomosis Clamp
16.5 cm,



Cooley-Beck
AC-9-213-17
Anastomosis Clamp
17 cm,

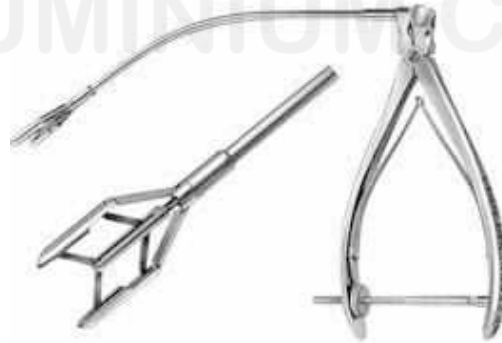

Cooley
AC-9-214-00
Aortic Dilator



Cooley
AC-9-215-05
Vascular Dilator
13 cm 0,5 mm ?,

Cardiovascular



DeBakey
AC-9-216-05
Vascular Dilator
19 cm 0,5 mm ?,

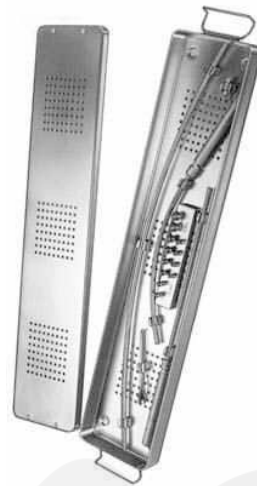

Martin
AC-9-217-00
Tunneling Set complete set with three shafts,
two handles and 12 tips in storage case.



Hach
AC-9-218-01
Fasciotomy Knife with plastic handle
30 cm,



AC-9-219-18
Intima Spatula
18.5 cm,

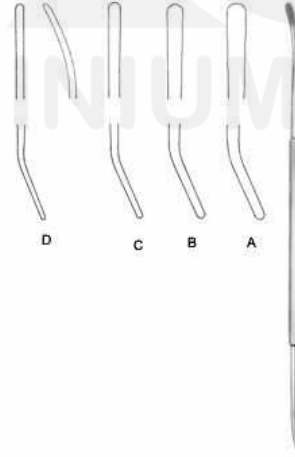

Robb
AC-9-220-01
Vascular Dissector
24 cm Fig. 1 2,5 mm ?, 24 cm Fig. 2 2,0 mm



Crile
AC-9-221-20
Nerve Hooklet
20 cm,



+92 331 7888484



+1 (936) 499-0711



info@aluminiumcart.com



www.aluminiumcart.com



Daburji Mallian Gass Street Daska
Road Sialkot 51310 Pakistan